



..2.0

Two holes,
zero external units



..2.0

3	INTRO
4	THE RANGE
7	POWER
10	DESIGN
14	VERSATILITY
17	DIMENSIONS
18	TWO HOLES
21	CONTROLS
26	..2.0 AMERICA
34	ALL MODELS



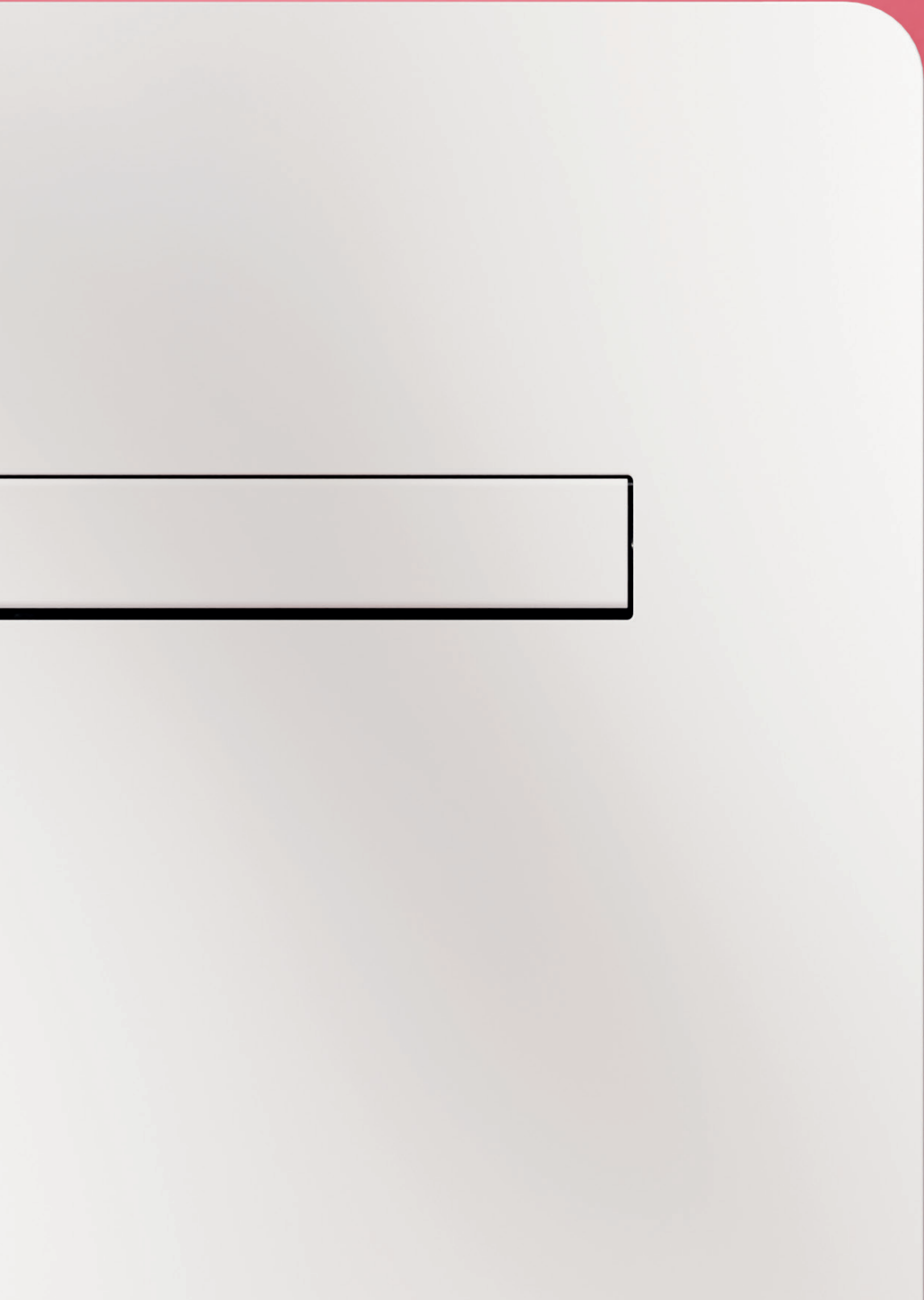

Two holes, zero external units.

Almost invisible, powerful, silent, and compact: this is the INNOVA air conditioner without an external unit.

Say goodbye to the usual bulky and unsightly condensing units that ruin residential aesthetics. INNOVA has developed a high-efficiency solution with a hyper-compact design to minimize visual impact.

With only 16.5 centimeters of depth, ultra-simple installation, and DC Inverter technology to optimize performance.

7 models, from floor to ceiling.

The conquest of space.

7 models, from floor to ceiling, in the center, on the side, or in a corner... When space is limited or insufficient, INNOVA has the perfect solution.

Not only air conditioners without an external unit but also systems designed to make use of every available indoor surface, ensuring optimal comfort in every season of the year.



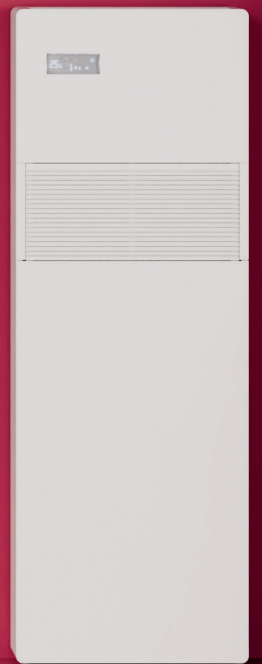
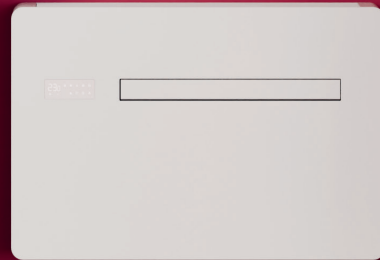
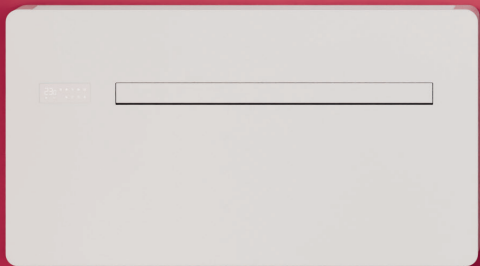
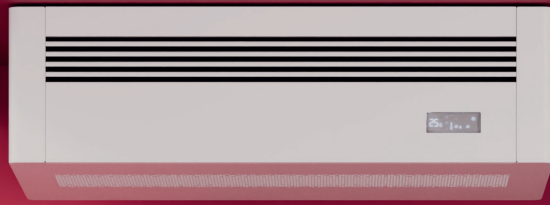

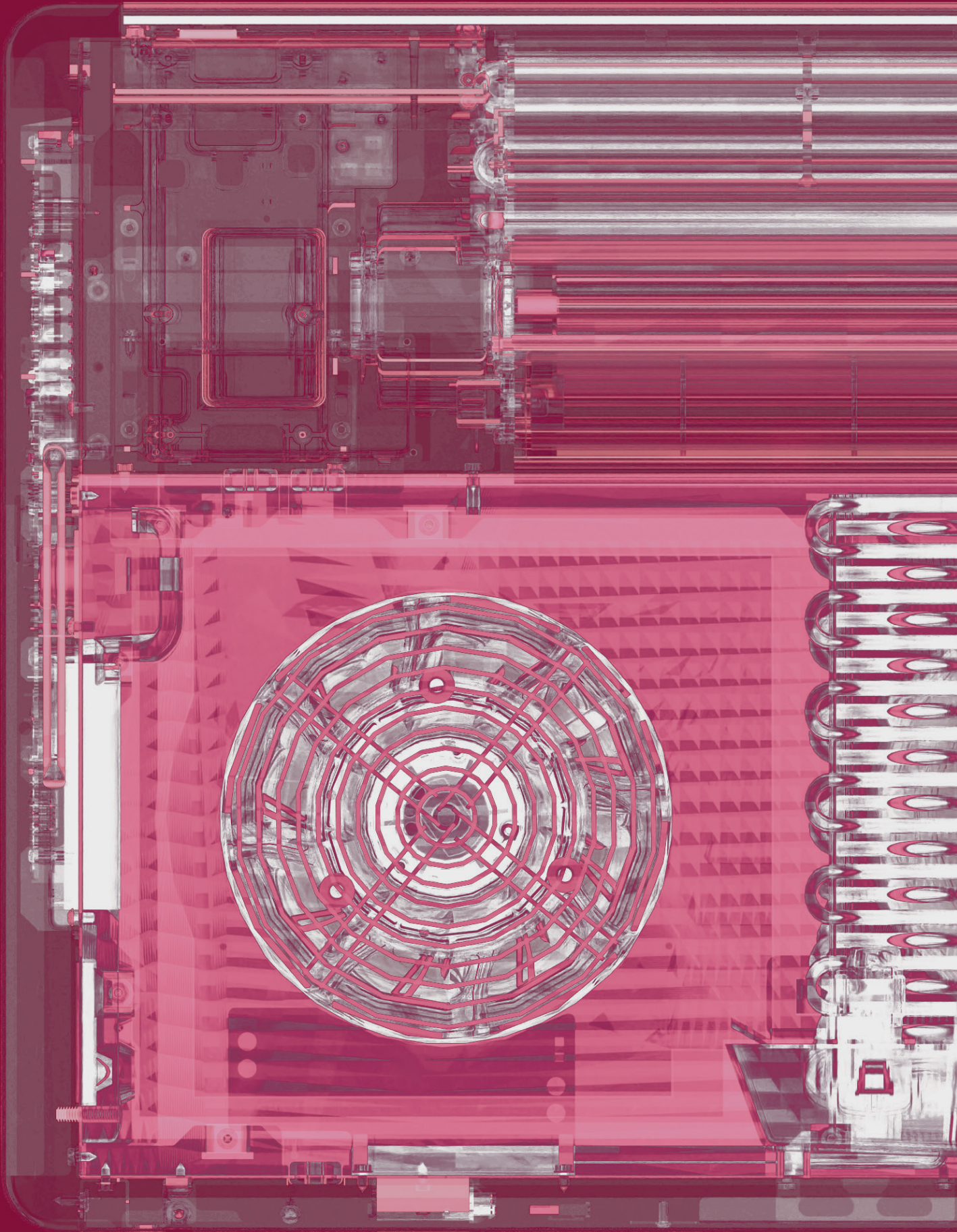

Power ratings in kW of the ..2.0 range

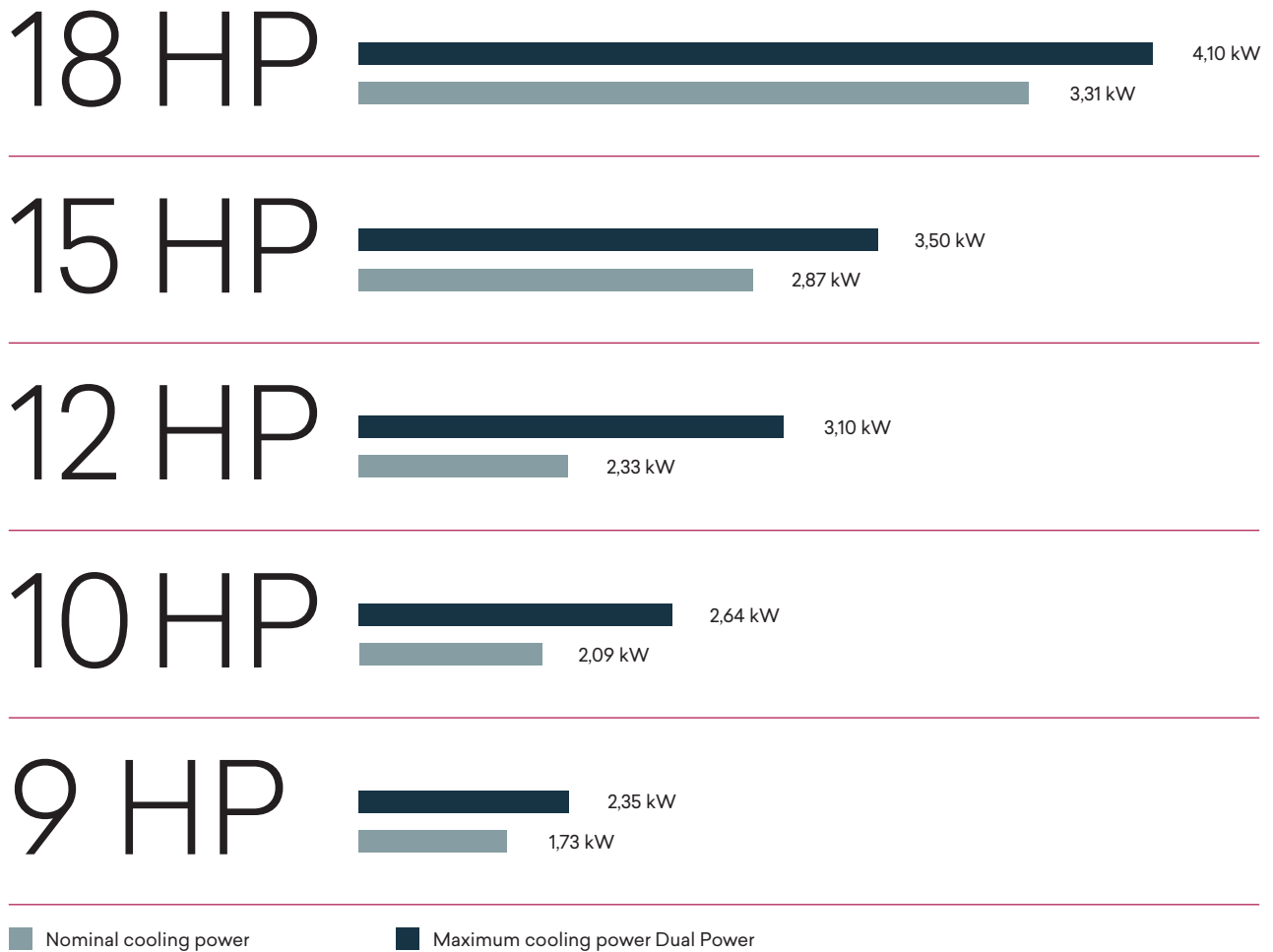

Performance

With DC Inverter technology, power is optimized to achieve maximum comfort with lower energy consumption and noise. Thanks to Dual Power, maximum power can be utilized to reach the desired temperature in the shortest possible time. Once the temperature is reached, ..2.0 automatically adjusts to maintain optimal comfort.





25°C

innova



Form follows function.

The minimal depth, the right color, the perfectly smooth surface, the fully metal body... a product designed to seamlessly integrate into any home environment, delivering excellent performance while at the same time... disappearing. In both horizontal and vertical configurations, the design of ..2.0 has been meticulously refined to perfectly blend form and function. ..2.0 features a 100% metal body—strong, durable, and solid.

During development, component sizes were minimized and optimized to incorporate all the necessary functions for perfect operation within a hyper-compact design. Depth? Just 16.5 centimeters. An ultra-thin profile that minimizes visual impact, both inside and out.







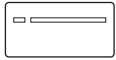
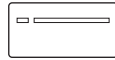
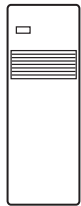

Down installation**Overhead installation****Installation on the side****Installation on ceiling**

Maximum versatility.

..2.0 from INNOVA can count on a complete product range that allows you to find the right model for every type of installation. All you need is an external wall and you can find the space to insert it high up on the wall, low down on the floor, in the corner or to the side of a French door or on ceiling. Maximum versatility to meet every need.

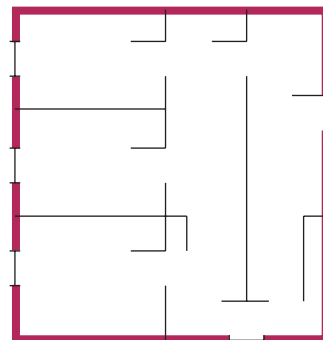
Perimetral installation

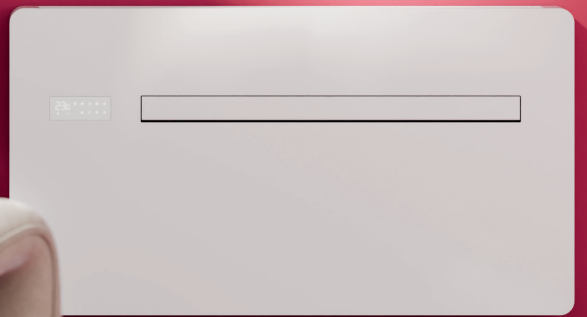
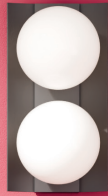



Dimensions.

**..2.0
..2.0 MAXI
..2.0 AMERICA**

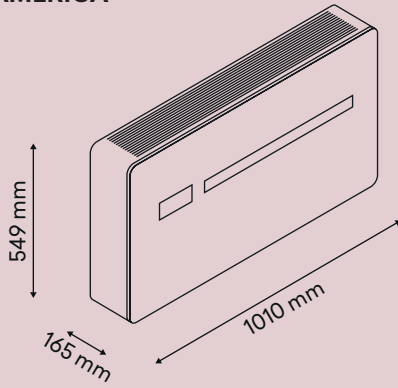

41 kg

..2.0 MINI

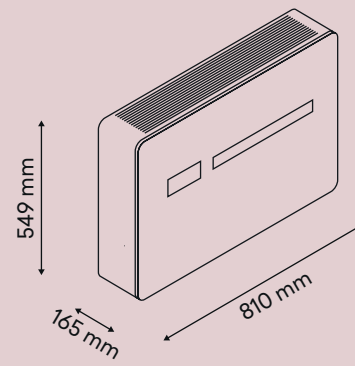

38 kg

..2.0 VERTICALE

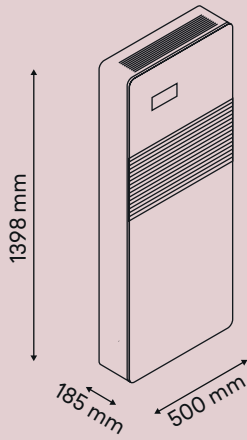

57 kg

..2.0 CEILING

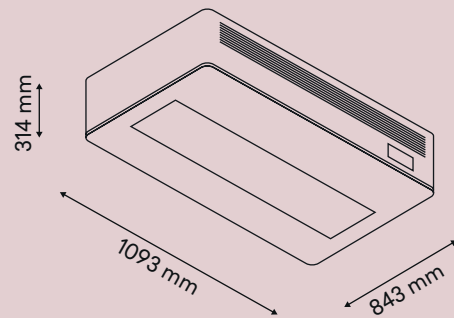

69 kg

Size of the two wall holes.

Ø 162 mm

..2.0
..2.0 MINI
..2.0 VERTICALE
..2.0 CEILING

Ø 202 mm

..2.0 MAXI
..2.0 AMERICA

Only two holes.

Important for both design and installation:
easier to find drilling tools, no need for
professional drills, and even less visual
impact.

Grilles with internal
fastening.

..2.0
..2.0 MINI
..2.0 VERTICALE
..2.0 CEILING
..2.0 MAXI



Grilles with external
fastening.

..2.0 AMERICA

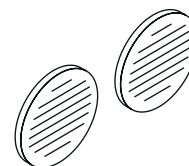

23.0 °C





Integrated touch-screen.



Remote touch-screen.



Handset control.

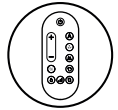

iOS and Android APP.



M7 series

Command.

With M7, INNOVA expertly combines design and technology to create a new series of controls—M7—undoubtedly at the top of its category.

The innovations start with the user panel, now featuring touch technology with increased sensitivity and automatic brightness adjustment.

Functionality has been enhanced, and in the wall-mounted version, the panel's thickness is nearly halved, ensuring perfect compatibility with the 503 electrical box, the most widely used on the market.

A true concentration of technology—a perfect blend of beauty and practicality.





The right temperature, anywhere.

Technology is nothing if it doesn't provide the right comfort... With the new ..2.0 range, air circulation has been improved to ensure optimal well-being in every corner of the room. No matter the model, comfort is always at home!



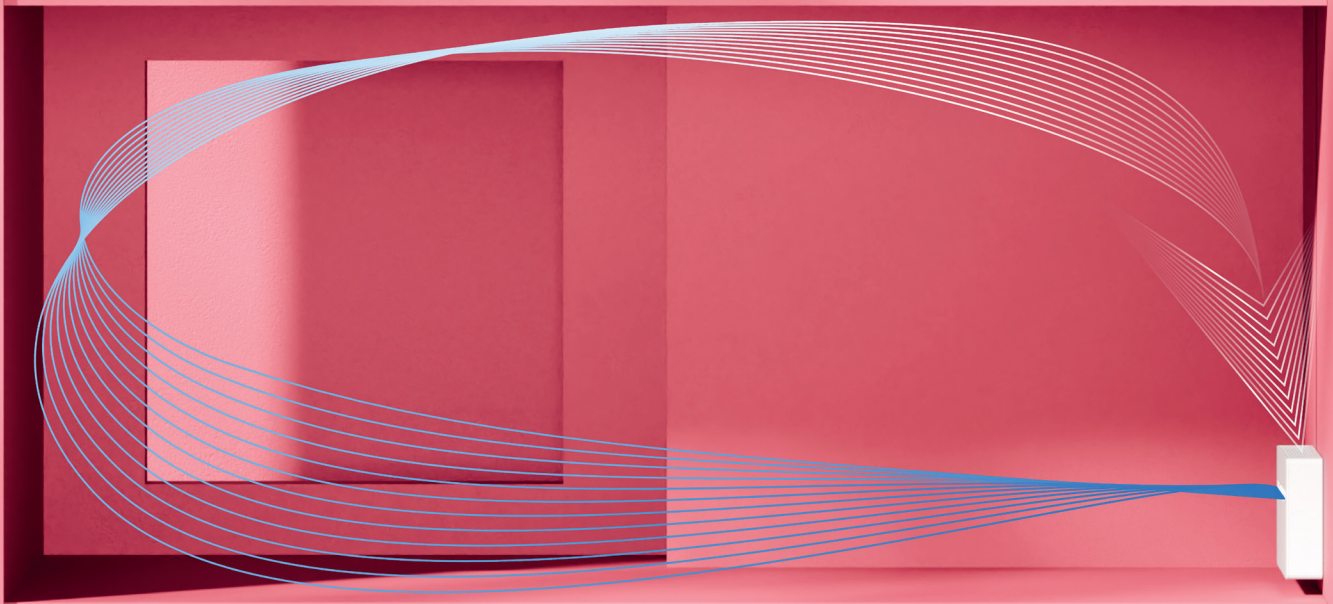
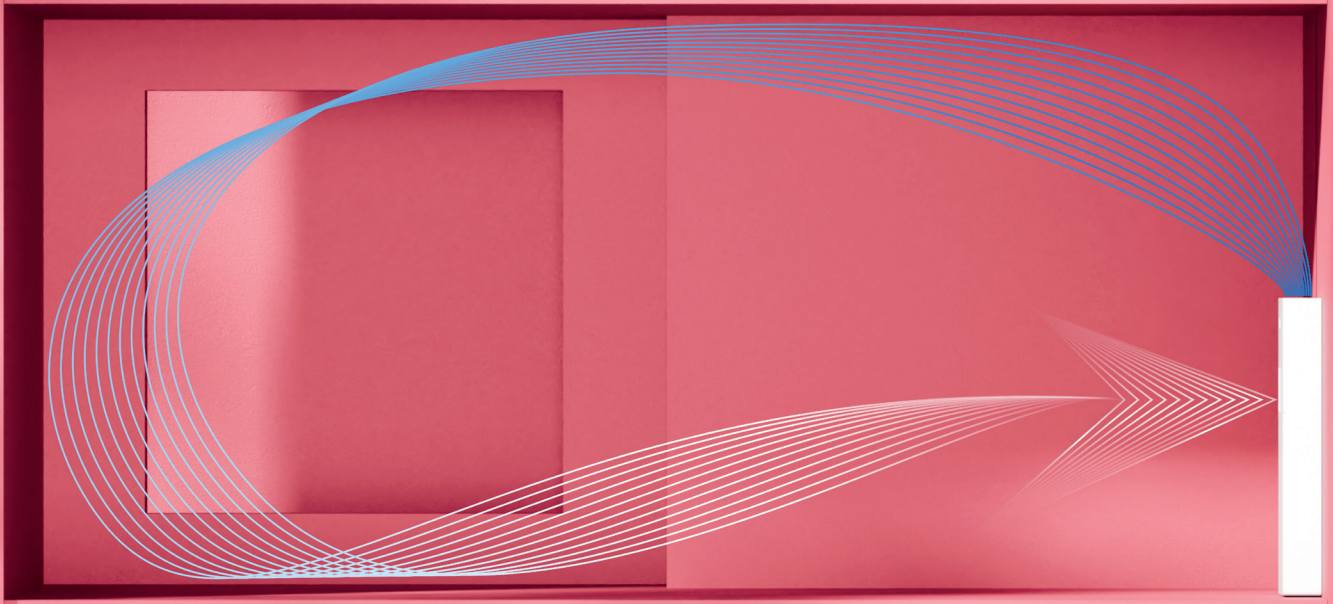
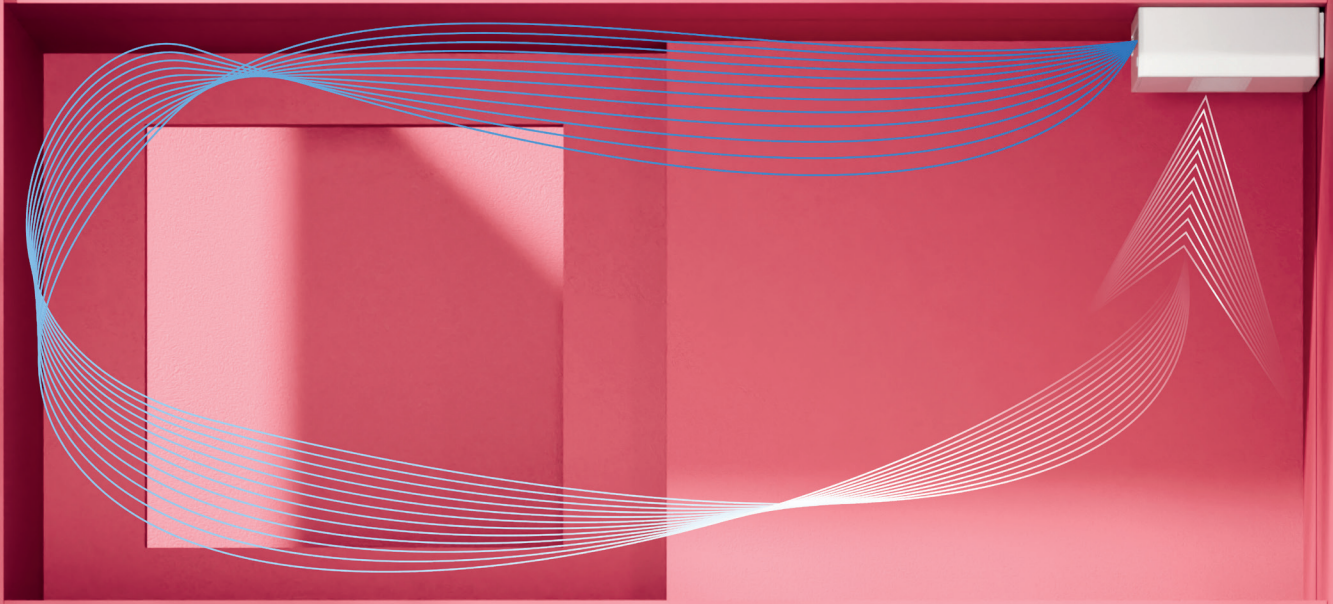

NEW

..2.0 AMERICA

The United States of America—a country with high demands when it comes to air conditioning, with one key requirement: high power.

Specifically designed and built to meet the demands of the U.S. market—characterized not only by large domestic spaces but also by extreme temperature variations in both summer and winter—..2.0 AMERICA features unique, cutting-edge technological solutions that have led to great success overseas.

Now available in Europe, ..2.0 AMERICA is truly capable of air conditioning larger spaces, opening up new possibilities and opportunities for this type of product.



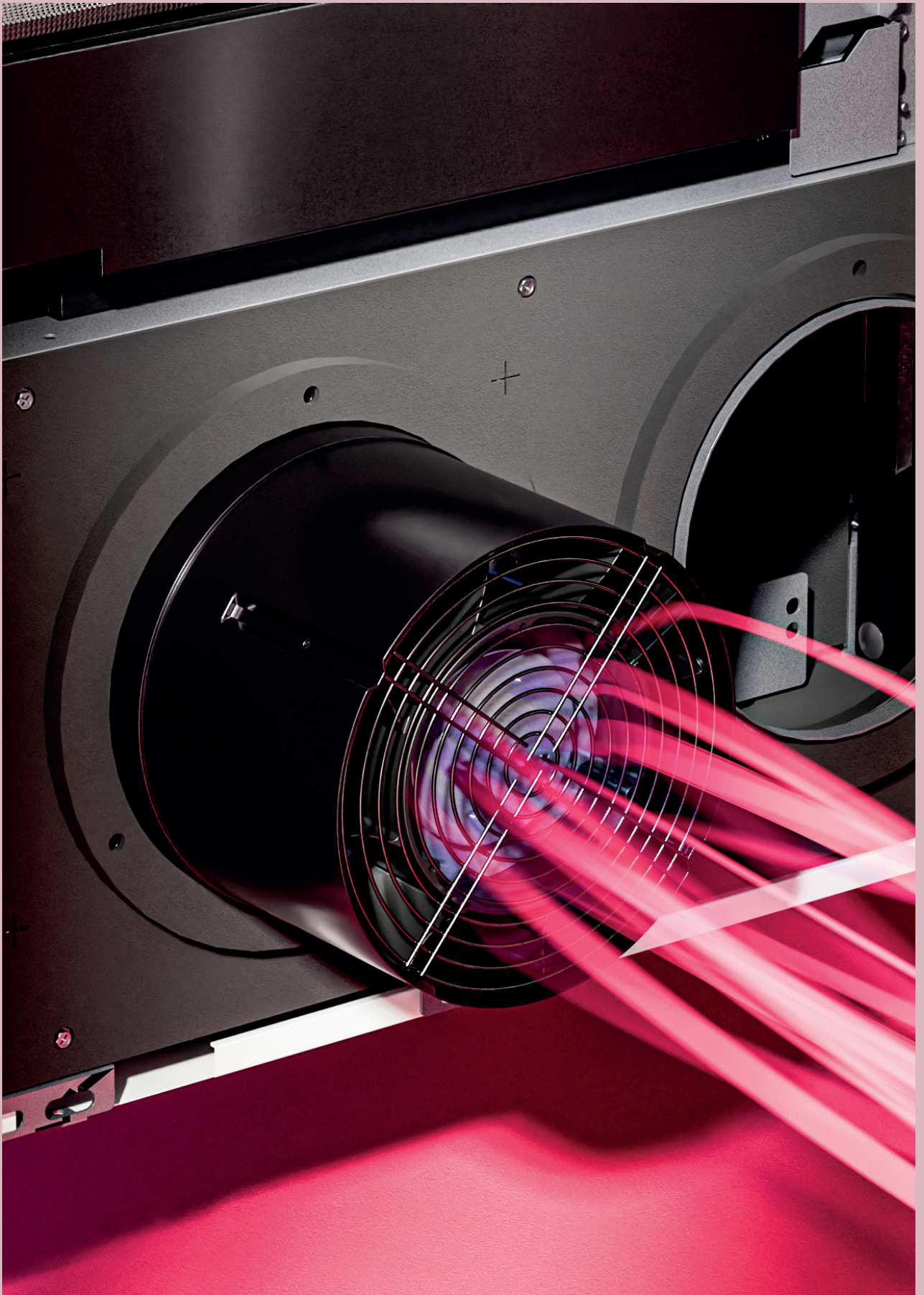

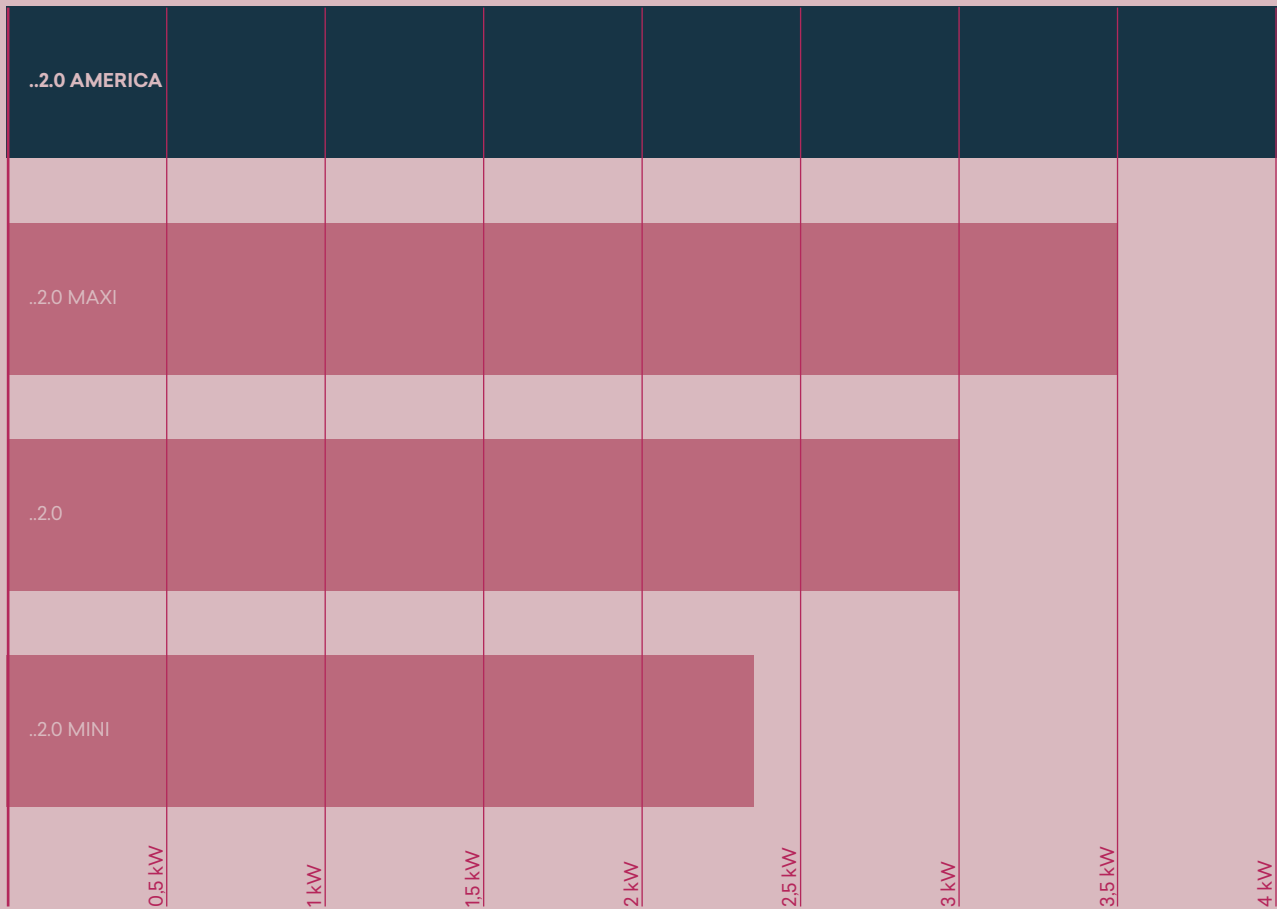

*Maximum heating power Dual Power

New axial fan.

There are no secrets, just pure technological research: the higher power of ..2.0 AMERICA is achieved thanks to a new-generation, patented axial fan that significantly increases the volume of treated air and, consequently, the unit's power. This innovation, combined with the experience gained in the U.S. market, allows us to introduce a product that stands unrivaled in the industry.

Installation? Practically the same...

The installation of ..2.0 AMERICA follows the same familiar logic. The only difference is that the new axial fan, housed in the air intake, must be removed and inserted into the wall's air exhaust hole, then electrically connected to the unit.

Just a few extra simple steps to finally have a high-power product—efficient and silent, as always!









R290

..2.0^{MINI}

The tiny air conditioner.

Model 9 HP	
Refrigerant gas R290	
Movable external grilles Internal fastening	
External holes Diameter 162 mm	
Superplus Only 81 cm wide	

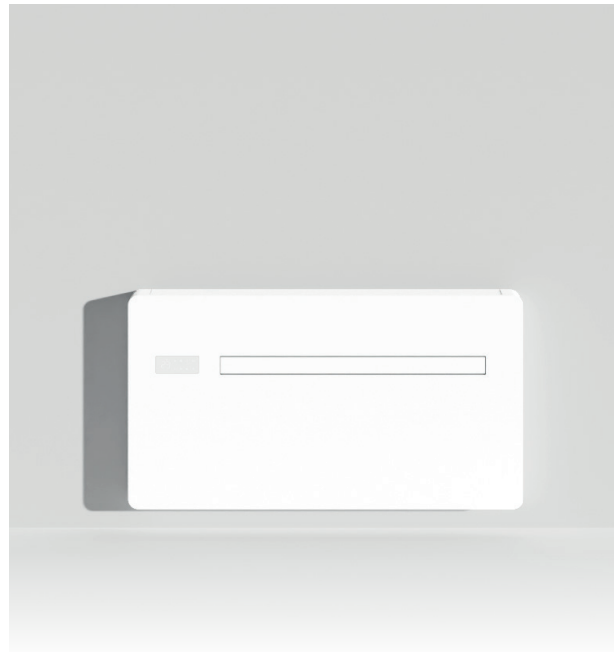

..2.0

Now a classic.



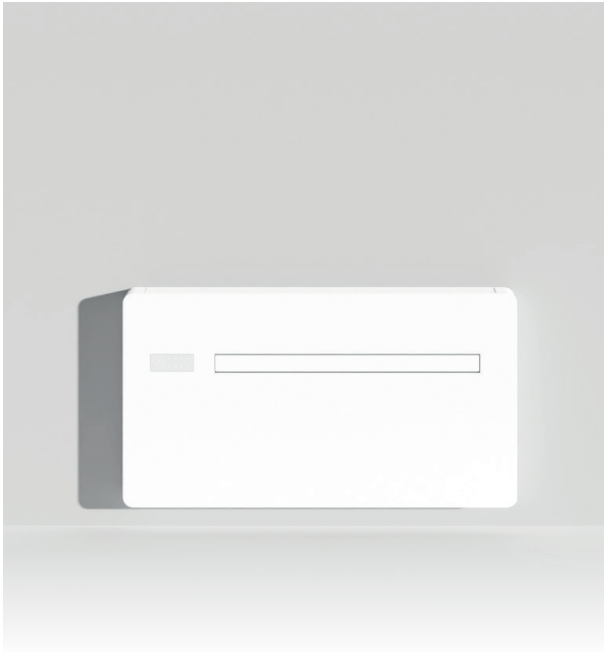

Model 10 HP – 12 HP	
Version with electric heater 12 HP ELEC 2 kW	
Refrigerant gas R32	
Movable external grilles Internal fastening	
External holes Diameter 162 mm	





..2.0 MAXI





The ..2.0 with MAXI power.

Model 15 HP	
Version with electric heater 15 HP ELEC 2 kW	
Refrigerant gas R32	
Movable external grilles Internal fastening	
External holes Diameter 202 mm	
Superplus 3.5 kW maximum cooling power Dual Power	



..2.0 AMERICA





Large spaces, great power.

Model 18 HP ELEC 2 kW	
Refrigerant gas R32	
Movable external grilles Internal fastening	
External holes Diameter 202 mm	
Superplus <ul style="list-style-type: none"> • Cools rooms 30% larger • Axial fan 	



..2.0 VERTICALE



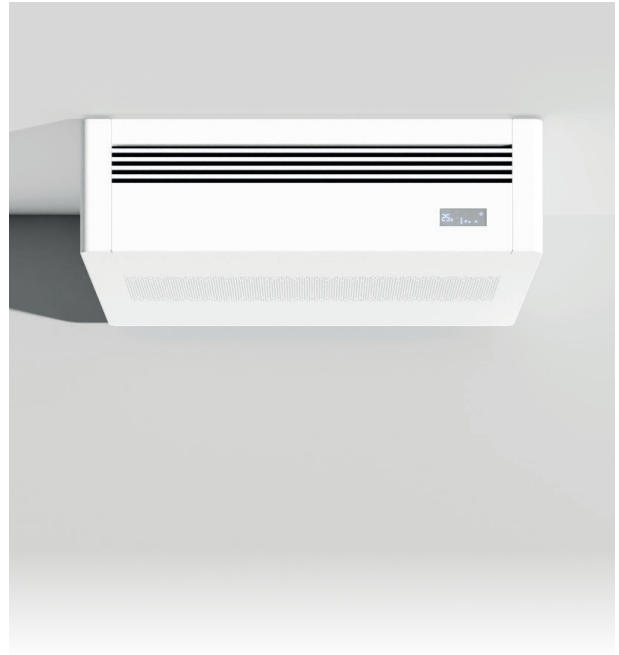

For when there's absolutely no space.

Model 10 HP – 12 HP	
Refrigerant gas R410a	
Movable external grilles Internal fastening	
External holes Diameter 162 mm	



..2.0 CEILING

Under the ceiling.

Model 12 HP – 12 HP ELEC	
Refrigerant gas R32	
Movable external grilles Internal fastening	
External holes Diameter 162 mm	

Superplus

Ceiling installation





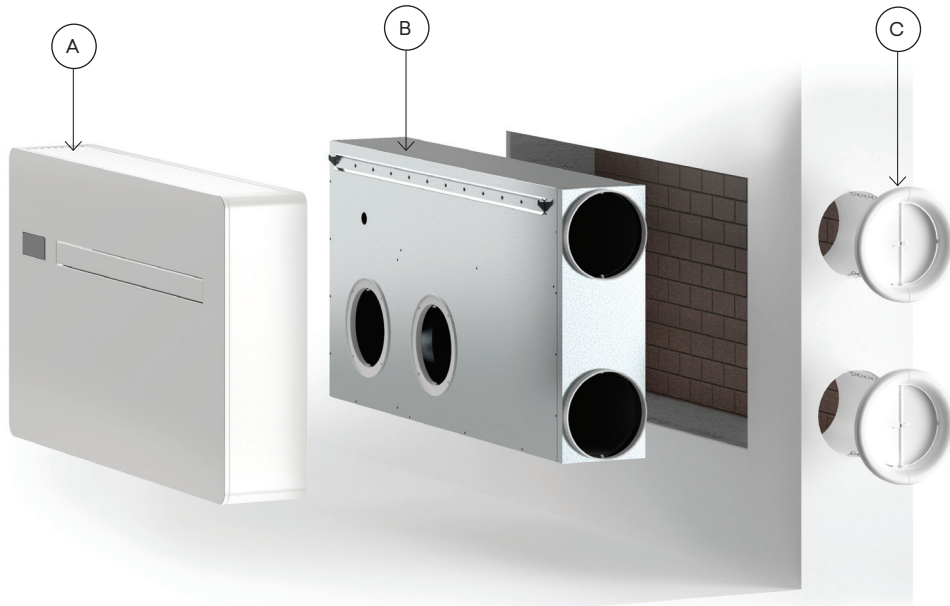

- Ⓐ ..2.0 for wall mounting.
- Ⓑ Recessed side installation kit.
- Ⓒ Foldable external grilles.

Side installation kit.

Air conditioners without an external unit are always installed on a perimeter wall to exchange air with the outside.

In some cases, this is not possible because the "outside" is lateral to the wall where the unit is installed.

With this wall-recessed kit, the airflow is diverted sideways, allowing ..2.0 to be mounted on the wall while having a lateral air outlet. This opens up many new and unexpected installation possibilities!

Accessory kit for ..2.0 10 HP and ..2.0 12 HP / ELEC 2 kW.

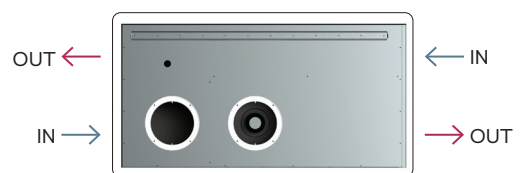

Completely made of metal.

1

The body of ..2.0 is completely made of metal, with all plastic parts eliminated. Strong and durable, ..2.0 is now even more solid and robust.

Touch screen + remote control.

2

The large control panel allows you to select every operating parameter directly on the unit—and also manage communication via Wi-Fi.

High-efficiency coil.

3

The condenser coil is high-efficiency with an evaporative condensation system, ensuring even greater performance.

Hyper-compact design.

4

A hyper-compact body integrates everything needed for the product's optimal operation, thanks to meticulous design and engineering aimed at reducing the size of each component while ensuring perfect functionality.

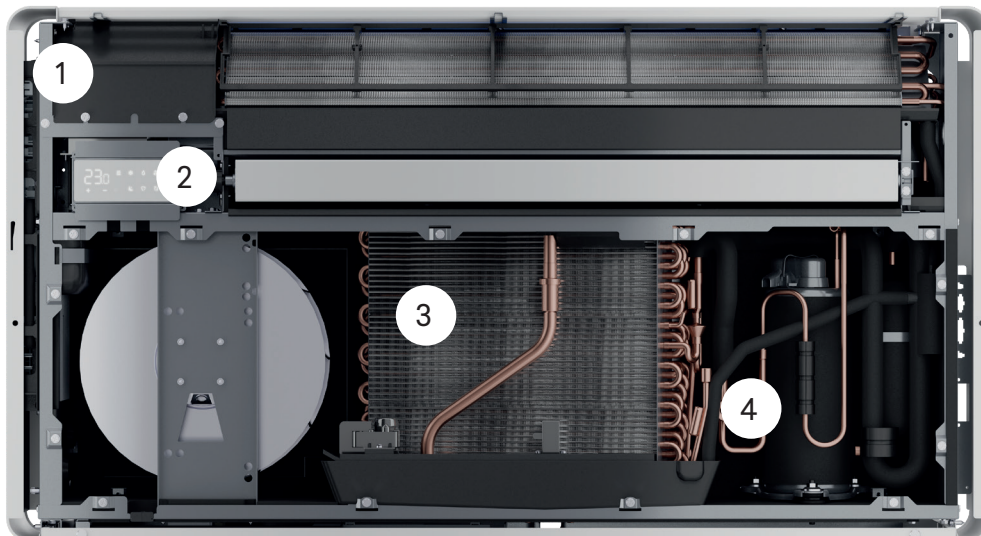

Command ..2.0, ..2.0 MINI and ..2.0 AMERICA

M7 SERIES

On board machine - SERIE M7

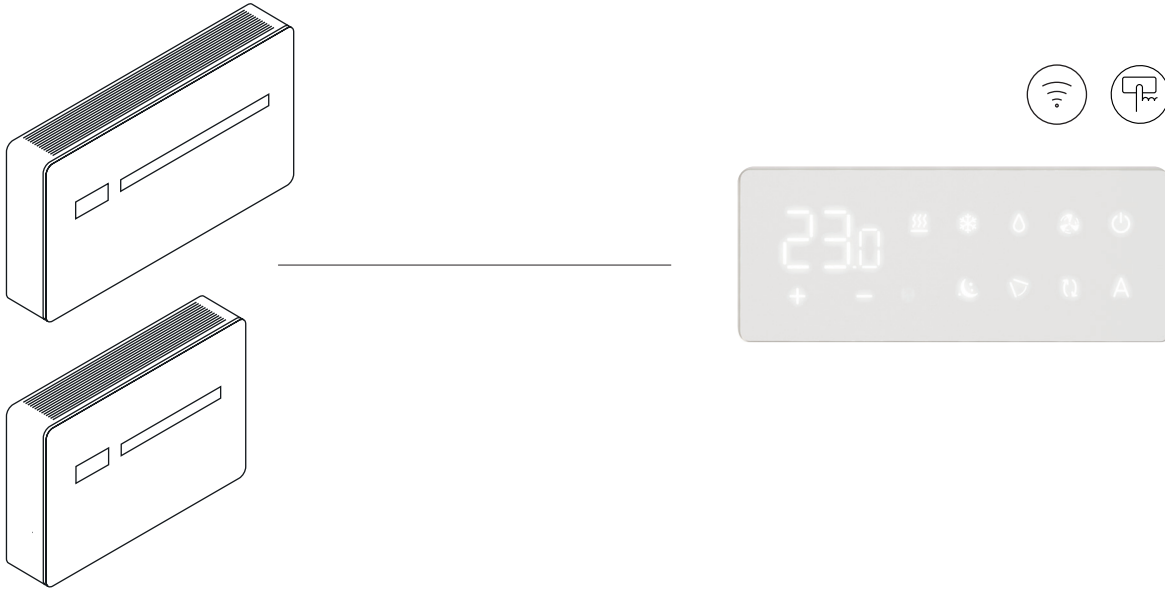

Wall-mounted - M7 SERIES



Code:
EEB749II

- PI Logic
- Touch interface
- Controls up to 16 units
- RS485 Modbus port for BUTLER or BMS
- Accessory kit for recessed boxes



Code:
EFB749II

- PI Logic
- Touch interface
- Controls up to 16 units
- Wi-Fi connection
- Accessory kit for recessed boxes

Remote control

Supplied as standard.

- Ability to control the airflow direction
- Fan speed control

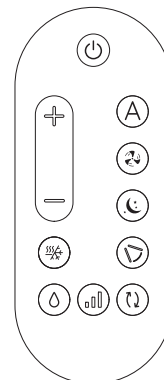

Command ..2.0 VERTICALE

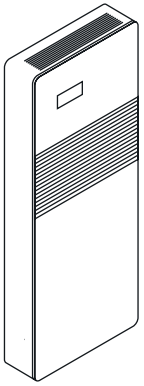

Remote control ..2.0 VERTICAL

- Fan speed control

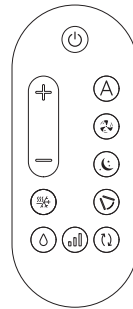

Command ..2.0 CEILING

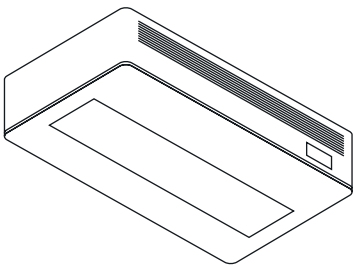

Remote control ..2.0 CEILING

- Fan speed control

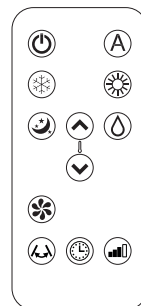

Accessories

Fixed-louver external grille kit DN 160.

Description

Accessory supplied upon request, as an alternative to the standard foldable grilles.
The fixed louvers are made of anodized aluminum.

Codes

GB0738II for ..2.0 / ..2.0 MINI / ..2.0 ELEC 2 kW 12HP / ..2.0 VERTICALE / ..2.0 CEILING

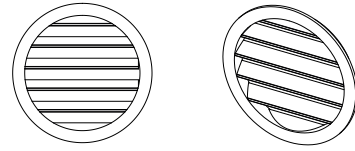

Fixed-louver external grille kit DN 200.

Codes

GB1091II for ..2.0 MAXI / ..2.0 ELEC 2 kW 15HP / ..2.0 AMERICA

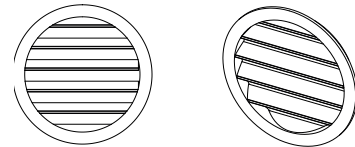

Rain protection kit.

Description

Upper hole cover, suitable for installations on walls exposed to rain and wind. This accessory is supplied upon request and is only compatible with fixed-louver external grilles.
The package includes two covers, one for each grille.
Color: White RAL 9003.

Functionality

The accessory, positioned at the top of the grilles, protects the hole from weather conditions.

Codes

GB0739II for ..2.0 / ..2.0 MINI / ..2.0 VERTICALE / ..2.0 CEILING

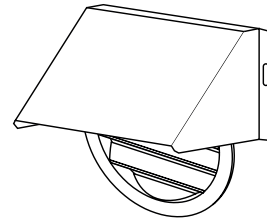

Kit No.1 insect protection.

Description

Kit composed of:
1 metal mesh disc
1 wire mesh grid
screws and fixing plugs

Accessory provided upon request and applicable to external grills with fixed blades. It further protects the holes, preventing the possible entry of insects or small debris.

Codes

GB0755II for ..2.0 / ..2.0 MINI / ..2.0 VERTICALE / ..2.0 CEILING

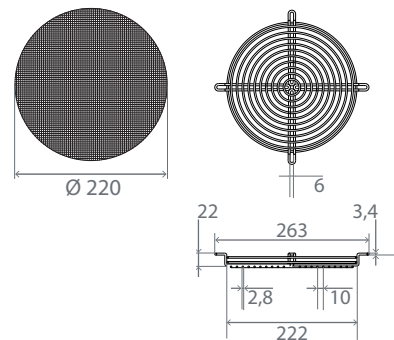

Formwork with lateral exit.

Description

Recessed formwork for corner installation with right-side exit. Depth 165 mm.

Codes

L00773II per ..2.0 / ..2.0 ELEC 2 kW 12HP

Recessed formwork for corner installation with left-side exit. Depth 165 mm.

Codes

L00774II for ..2.0 / ..2.0 ELEC 2 kW 12HP

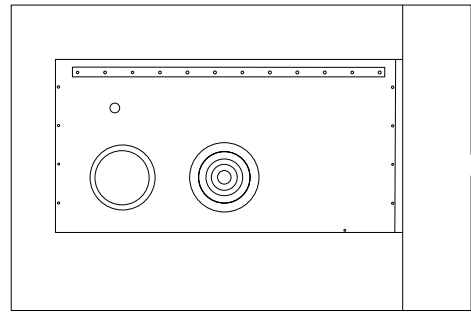

Pre-installation kit.

Description

Kit composed of:
 2 external grills for air intake and exhaust, including springs and chains (A)
 6 screw and plug kits (B)
 Wall anchoring bracket (C)
 Paper template for hole drilling (F)
 2 retractable wall tubes (H)
 Installer manual (N)
 Internal wall counterflange (O)

Functionality

This kit is used for preparing the spaces and holes for the future installation of the device. All components of this accessory are included in the box at the time of purchase.

Codes

GB0671II for ..2.0 with 162 mm holes / ..2.0 ELEC 2 kW 12HP

GB1092II for ..2.0 MAXI / ..2.0 AMERICA 18 HP / ..2.0 ELEC 2 kW 15HP with 202 mm holes

GB1109II for ..2.0 MINI 9 HP with 162 mm holes.

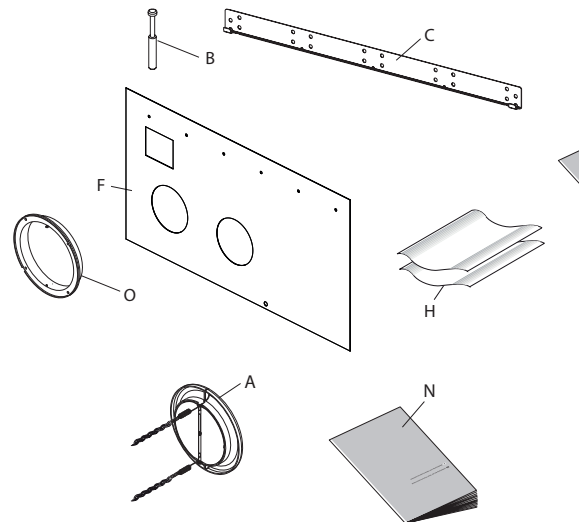

Heated condensate drainage tube.

Description

Heated condensate disposal tube with electric resistance.

Codes

GB1119II For all the ..2.0

Kit for installation on glass walls.

Description

Kit composed of:

- 1 aesthetic back panel, color white RAL 9003
- 2 floor mounting brackets for the ..2.0
- 1 front plinth to cover floor mounting brackets, RAL 9003
- Screws and fastening nuts

Functionality

The accessory has an aesthetic function in installations where the back part of the device is visible, such as when it is placed behind a display case.

Codes

GB0740II for ..2.0 / ..2.0 ELEC 2 kW 12HP

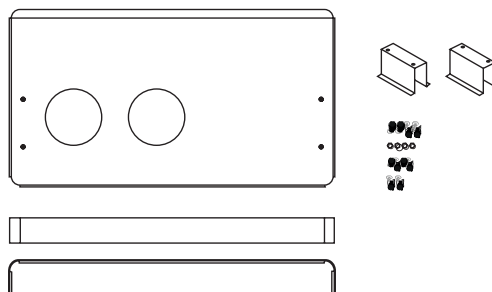

Aesthetic kit for bottom cover

Description

The bottom cover is made of painted galvanized sheet metal in the same color as the device.

Functionality

The accessory has an aesthetic function in installations where the lower part of the device is visible, such as for ceiling-mounted installations.

Codes

GB0737II for ..2.0 / ..2.0 AMERICA / ..2.0 ELEC 2 kW

GB1105II for ..2.0 MINI

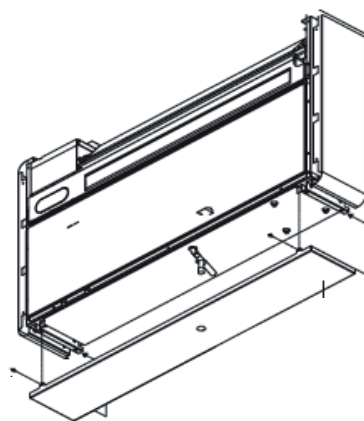







MODELS		..2.0 MINI	..2.0			..2.0 ELEC 2 kW		..2.0 AMERICA
	u.m.	9 HP	10 HP	12 HP	15 HP	12 HP	15 HP	18 HP

General features

Maximum indoor air flow rate	m³/h	360	380	400	450	400	450	500
Maximum external air flow rate	m³/h	430	460	480	550	480	550	750
Average indoor air flow rate	m³/h	300	310	320	350	320	350	400
Average outside air flow rate	m³/h	360	380	390	460	390	460	550
Minimum indoor air flow rate	m³/h	240	260	270	300	270	300	300
Minimum external air flow rate	m³/h	320	330	340	400	340	400	400
Compressor type		Rotary - DC Inverter						

Sound data

Nominal sound pressure	(7)	dB(A)	39	39	41	43	41	43	46
Minimum sound pressure	(7)	dB(A)	27	26	27	29	27	29	30

Refrigerant gas data

Refrigerant		R290	R32	R32	R32	R32	R32	R32
Refrigerant charge	Kg	0,14	0,50	0,50	0,50	0,50	0,50	0,50

Product dimensions and weights

Width	mm	810	1010	1010	1010	1010	1010	1010
Height	mm	549	549	549	549	549	549	549
Depth	mm	165	165	165	165	165	165	165
Empty weight	kg	38,0	41,0	41,0	41,0	41,0	41,0	202
Wall hole diameter	mm	162	162	162	202	162	202	293
Wall hole spacing	mm	293	293	293	293	293	293	41,0

(1) Outdoor air temperature 35°; relative humidity 41%. Ambient air temperature 27°C; relative humidity 47%. Performance according to EN 14511

(2) Energy classification according to Directive 626/2011 - Valid for fiscal deductions.

(3) Energy classification according to Directive EN 14825:2022.

(4) Outdoor air temperature 7 °C; relative humidity 87% / Ambient temperature 20 °C, relative humidity 59% / Performance according to EN 14511

(5) Efficiency according to EN 13141-7. Indoor temperature 20 °C - Indoor humidity 28% - Outdoor temperature 7 °C - Outdoor humidity 72%.

(6) 3 manual speeds plus automatic speed plus Boost.

(7) Sound pressure on the internal side in a semi-anechoic chamber at a distance of 2 meters.

Operating limits:

Min. cooling temperature T environment 18°C / T external -5°C

Max. cooling temperature T environment 32°C / T external 43°C

Min. heating temperature T environment 5 °C / T external -15 °C (- 25 °C for ELEC versions)

Max. heating temperature T environment 25 °C / T external 18 °C

Data Sheets

..2.0 Verticale & ..2.0 Ceiling

MODELS		..2.0 VERTICALE		..2.0 CEILING	
	u.m.	10 HP	12 HP	12 HP	12-ELEC
Cooling performance (A 35 °C; A 27 °C)					
Maximum cooling capacity Dual Power	(1)	kW	2,60	3,11	3,05 3,05
Nominal cooling power	(1)	kW	2,04	2,35	2,25 2,25
Minimum Cooling Capacity	(1)	kW	0,81	0,92	1,10 1,10
Dehumidification capacity		L/h	0,8	0,9	0,90 0,90
Total input power		kW	0,75	0,85	0,70 0,70
EER			2,72	2,75	3,21 3,21
Energy efficiency class	(2)		A	A	A A
Heating performance (A 7 °C; A 20 °C)					
Maximum heat output Dual Power	(3)	kW	2,64	3,05	3,00 3,00
Nominal heat power	(3)	kW	2,10	2,36	2,21 2,21
Minimum heat output	(3)	kW	0,68	0,79	0,94 0,94
Additional power heating element		kW	-	-	- 0,90/1,80
Total absorbed power	(3)	kW	0,67	0,75	0,70 0,70
COP			3,10	3,15	3,16 3,16
Energy efficiency class			A	A	A A
Electrical data					
Total input power		kW	0,95	1,06	1,15 2,05
Maximum absorbed current		A	4,40	4,80	5,10 9,00
Tension		V/ph/Hz	230/1/50	230/1/50	230/1/50 230/1/50
Internal aeraulic data (4)					
Ventilation speed		Nr.	3	3	- -
General features					
Maximum indoor air flow rate		m³/h	380	400	420 420
Maximum external air flow rate		m³/h	460	480	540 540
Average indoor air flow rate		m³/h	310	320	350 350
Average outside air flow rate		m³/h	380	390	450 450
Minimum indoor air flow rate		m³/h	260	270	280 280
Minimum external air flow rate		m³/h	330	340	360 360
Compressor type			Rotary - DC Inverter		Rotary - DC Inverter

MODELS	..2.0 VERTICALE			..2.0 CEILING		
	u.m.	10 HP	12 HP	12 HP	12-ELEC	
Sound data						
Nominal sound pressure	(5)	dB(A)	41	43	-	-
Minimum sound pressure	(5)	dB(A)	28	29	-	-
Room-side sound levels (6)						
Sound power transmitted to the structure Lw		dB(A)	-	-	62,0	62,0
Average sound pressure at 1 m Lp	(7)	dB(A)	-	-	48,0	48,0
Average sound pressure at 3 m Lp	(7)	dB(A)	-	-	40,0	40,0
Refrigerant gas data						
Type of refrigerant			R410a	R410a	R32	R32
Refrigerant quantity		Kg	0,56	0,56	0,50	0,50
Product dimensions and weights						
Width		mm	500	500	1093	1093
Height		mm	1398	1398	314	314
Depth		mm	185	185	843	843
Empty weight		Kg	57,0	57,0	69,0	69,0
Wall hole diameter		mm	162	162	162	162
Hole spacing on wall		mm	293	293	-	-

- (1) Outdoor air temperature 35°; relative humidity 41%. Ambient air temperature 27°C; relative humidity 47%. Performance according to EN 14511.
- (2) Energy classification according to Directive 626/2011 – Valid for tax deductions.
- (3) Outdoor air temperature 7 °C; relative humidity 87% / Ambient temperature 20 °C, relative humidity 59% / Performance according to EN 14511.
- (4) Efficiency according to EN 13141-7. Indoor temperature 20 °C - Indoor humidity 28% - Outdoor temperature 7 °C - Outdoor humidity 72%.
- (5) System-side sound pressure in semi-anechoic chamber at a distance of 2 m.
- (6) Data according to EN 3741 and EN 3744.
- (7) Sound pressure on the internal side measured in a semi-anechoic chamber according to UNI EN 3744.

BUTLER PRO



BUTLER PRO TOUCH
with integrated display

Display



BUTLER PRO
via WEB

Remote - PC

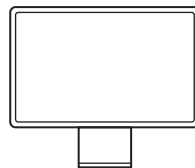

Tablet e Mobile



The advanced control of the system

The BUTLER PRO web server is the system developed by INNOVA to manage an entire heating and cooling system locally and remotely.

BUTLER PRO allows the connection of the heat pump, controlled mechanical ventilation, fan coil units, and all elements of the system, such as a radiant system, via a serial network.

BUTLER PRO is complete, simple, and intuitive: it is possible to set a weekly schedule with time slots, create scenarios by zones, and modify settings to ensure the house is at the right comfort level when needed.



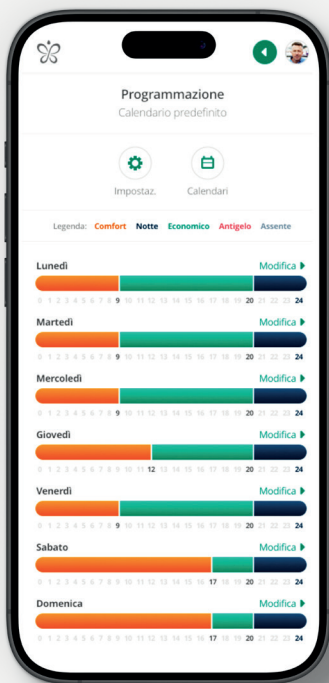
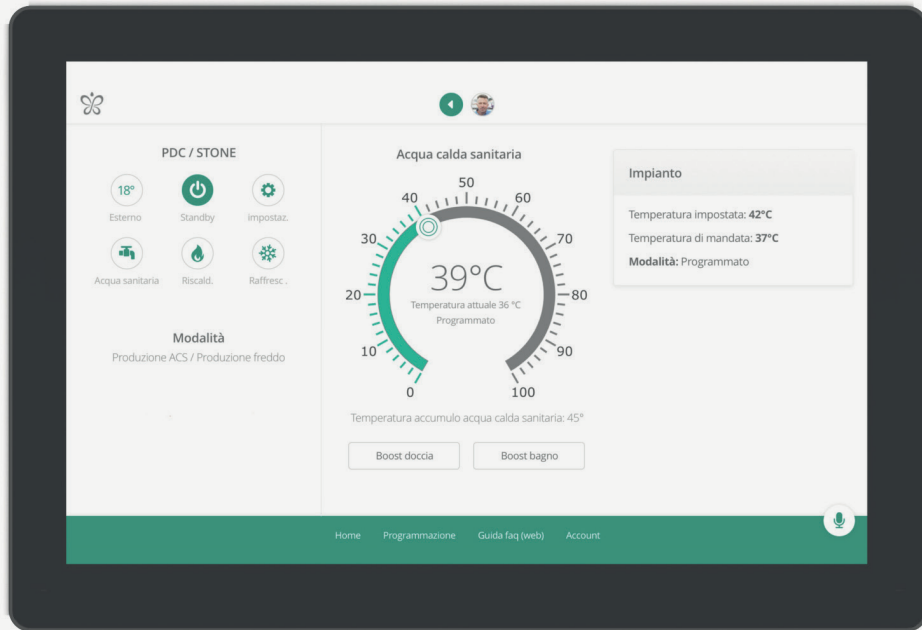

Supervision and control through local network or remotely

The system can be managed through a smartphone, tab-let or computer

Summer and winter personalised programming

Different programmes can be set for each season

Three temperature level setting on INNOVA fancoil network

For each room or zone it is possible to select 3 different work temperatures, which can be modified at any time

Weekly time programming

In each room it is possible to set different operating times

Network interface like the one on PCs

The connection to the webserver is the same as that of a normal computer once the bus network between the heat pump and the fan coils has been established

Remote assistance

With your consent, the BUTLER can automatically log on to the INNOVA cloud for diagnostics and assistance when necessary

Room control

Room-by-room control with BUTLER allows you to set a weekly schedule with time slots, create scenarios for each room or zone, and modify settings to ensure the house is at the right comfort level when needed.



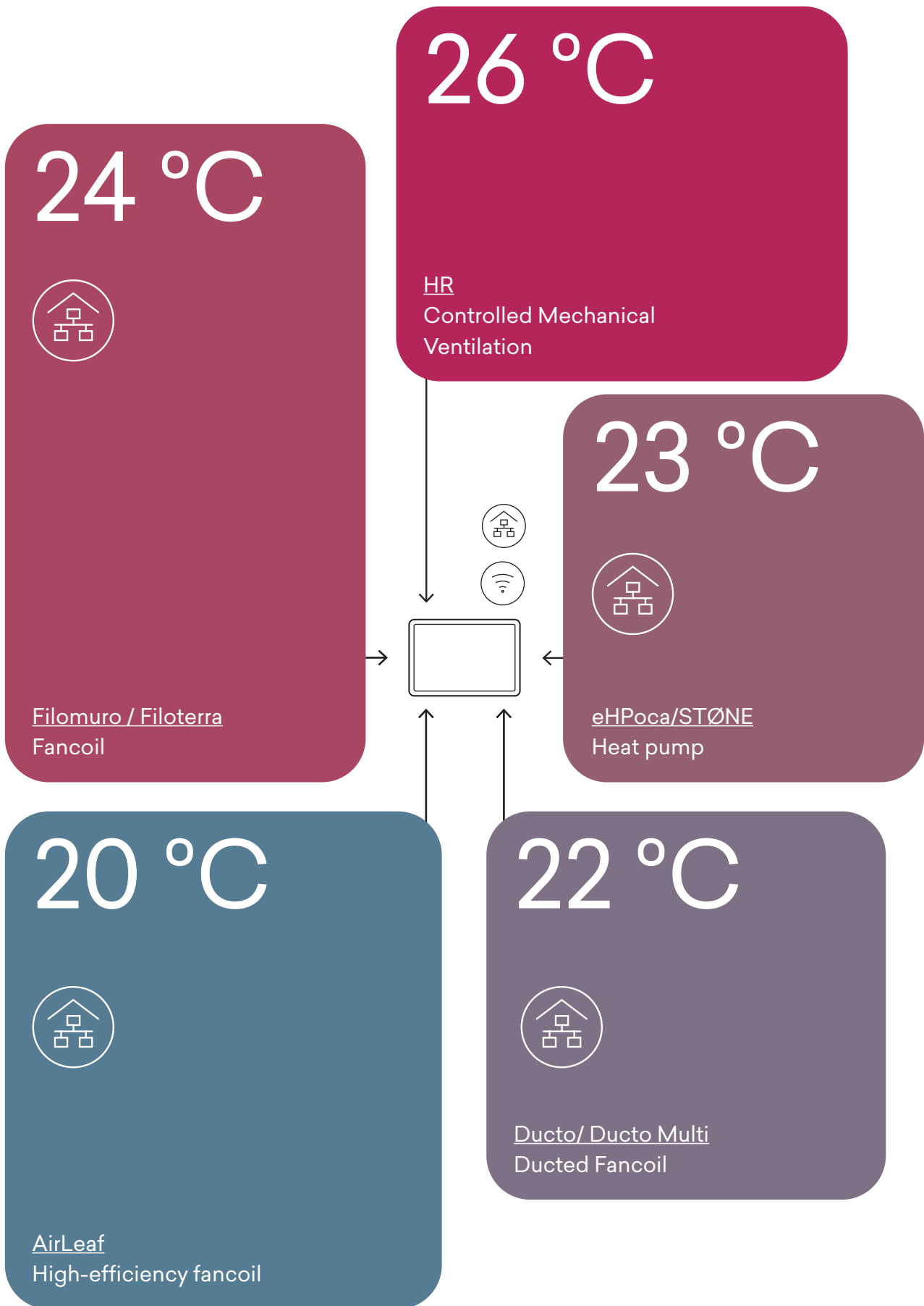

Web Server
BUTLER PRO

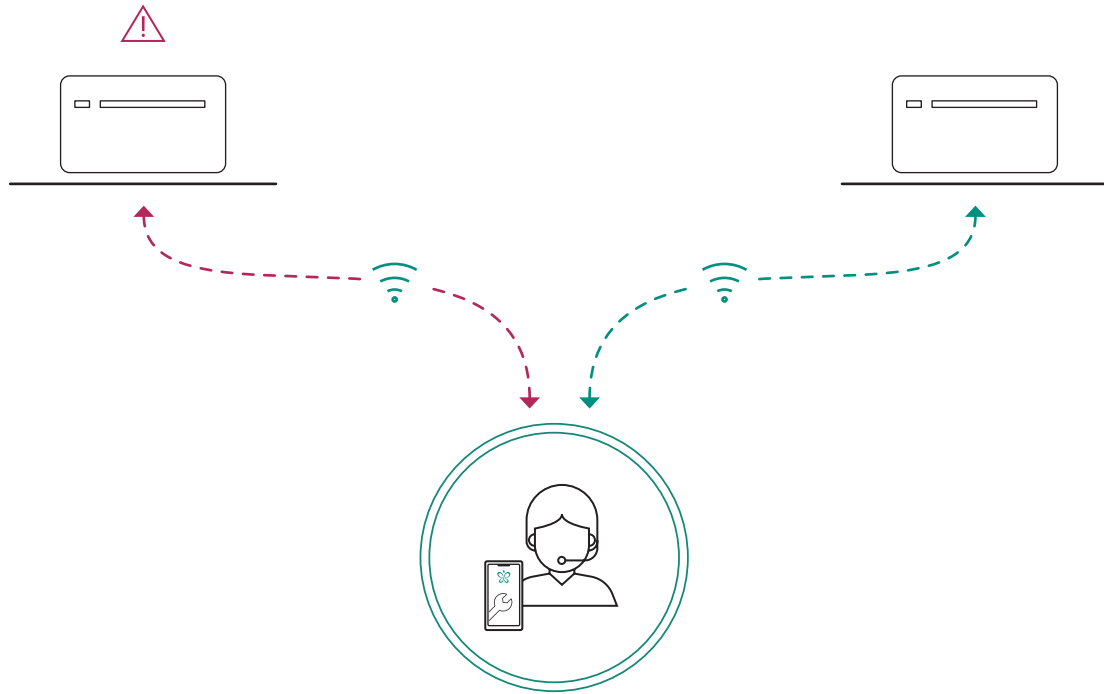

Remote assistance

BUTLER^{PRO}, with the user's consent, can automatically connect to the INNOVA cloud for diagnostics and support if needed. Thanks to the internet connection, it is possible to remotely verify the correct operation of INNOVA products connected to BUTLER^{PRO}. Any operational anomalies can be automatically sent by BUTLER^{PRO} to the support center, which can intervene by modifying the functional parameters or decide to intervene physically, providing fast and timely service.

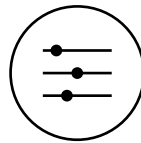

Total control

The advantage of choosing a complete system from INNOVA is that for any need, we are the sole point of contact for both scheduled maintenance and support. A complete and high-quality service.





Network commands.

For remote control and network management

Web Server BUTLER.

Fancoils with controls
code:
EEB749II

BUTLER^{PRO}

Web Server Kit BUTLER^{PRO} for
local and remote control.

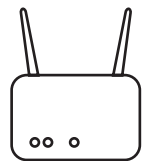
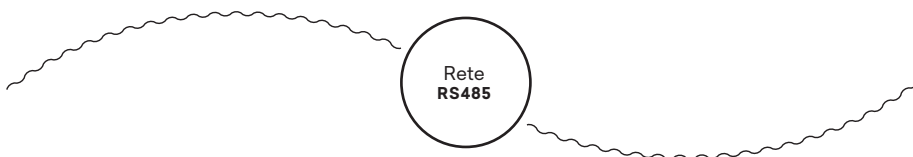
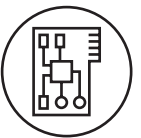

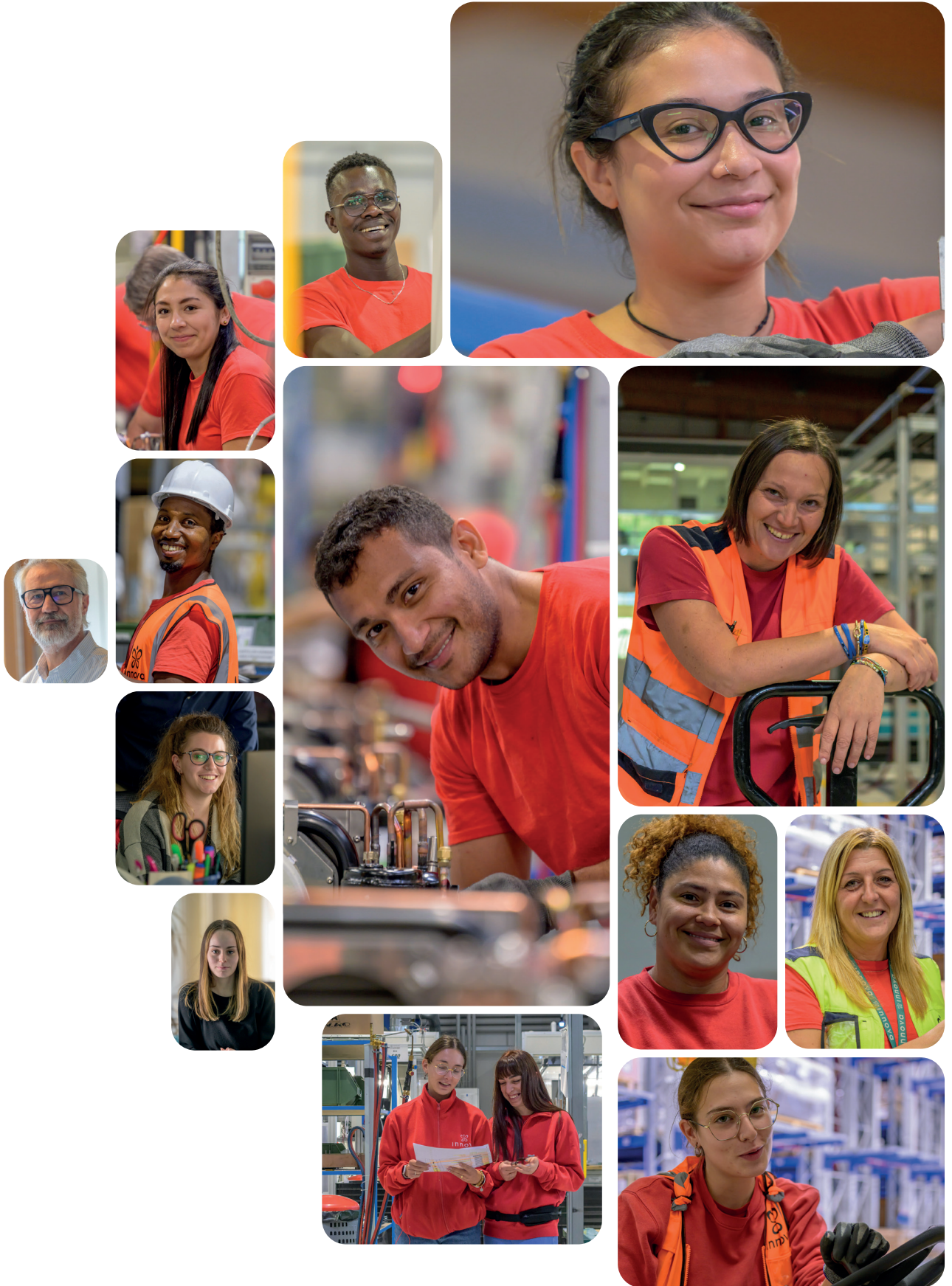

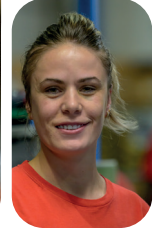

Ideas, products, people.



CREDITS

Product Designer

Luca Papini

Art Direction & Graphic

Osmo design

Photography

Ottavio Tomasini

Special thanks to:

Akira Nishikawa

©All rights reserved - photographs, images and texts are protected by copyright, any total or partial use not explicitly authorised by INNOVA will result in consequent sanctions. INNOVA reserves the right to make changes at any time to its products, accessories and technical data in order to improve its offer.





innova

INNOVA s.r.l.
Via 1° Maggio, 8
38089 Storo (Tn)
Tel. +39 0465 670104
Fax: +39 0465 674965
info@innovaenergie.com

innovaenergie.com

Edizione 2025/1