



KF-T120-315-4 L3

Art.no: [FAN000567](#)

Product category: Kitchen Fans

Technical data

PACKING	
Weight	46 kg
ELECTRICAL DATA	
Rated power	250 W
Rated current	0.75 A
Phases	3~ ~
Voltage	400 V
Frequency	50 Hz

FAN	
Motor type	AC
IP Class	IP55
Impeller type	Backwards curved
CASING	
Material	Galvanized steel
IP Class	IP54
Operation environment	Outdoors
Operating air temperature	-40 .. 120 °C

Dimensions

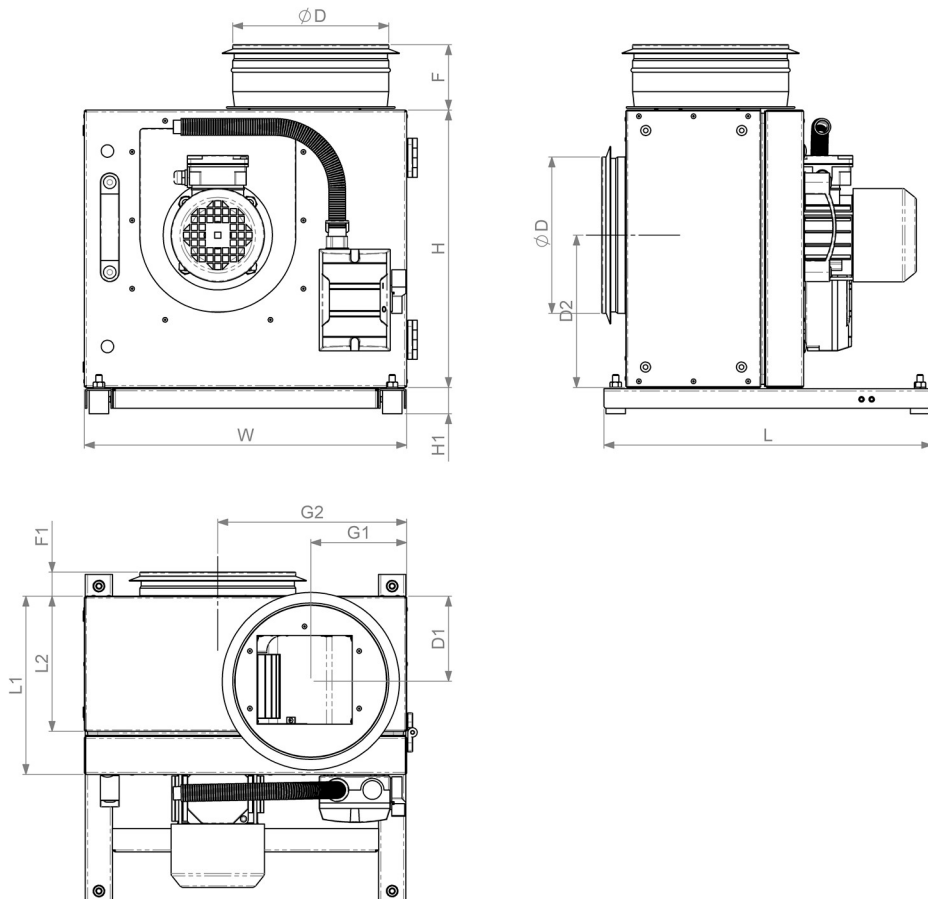

L [mm]	W [mm]	H [mm]	ØD [mm]	L1 [mm]	L2 [mm]	F [mm]	F1 [mm]	H1 [mm]	D1 [mm]	D2 [mm]	G1 [mm]
620	695	601	315	298	243	93	41	34	141	339	195
G2 [mm]											
410											