



**COWAY LOVES THE PLANET**  
This paper can be recycled.

# COWAY

## Coway Air Purifier AP-1516D

- This product is for domestic use only. It cannot be used in other overseas countries where the power voltage is different.
- Read and save these instructions.

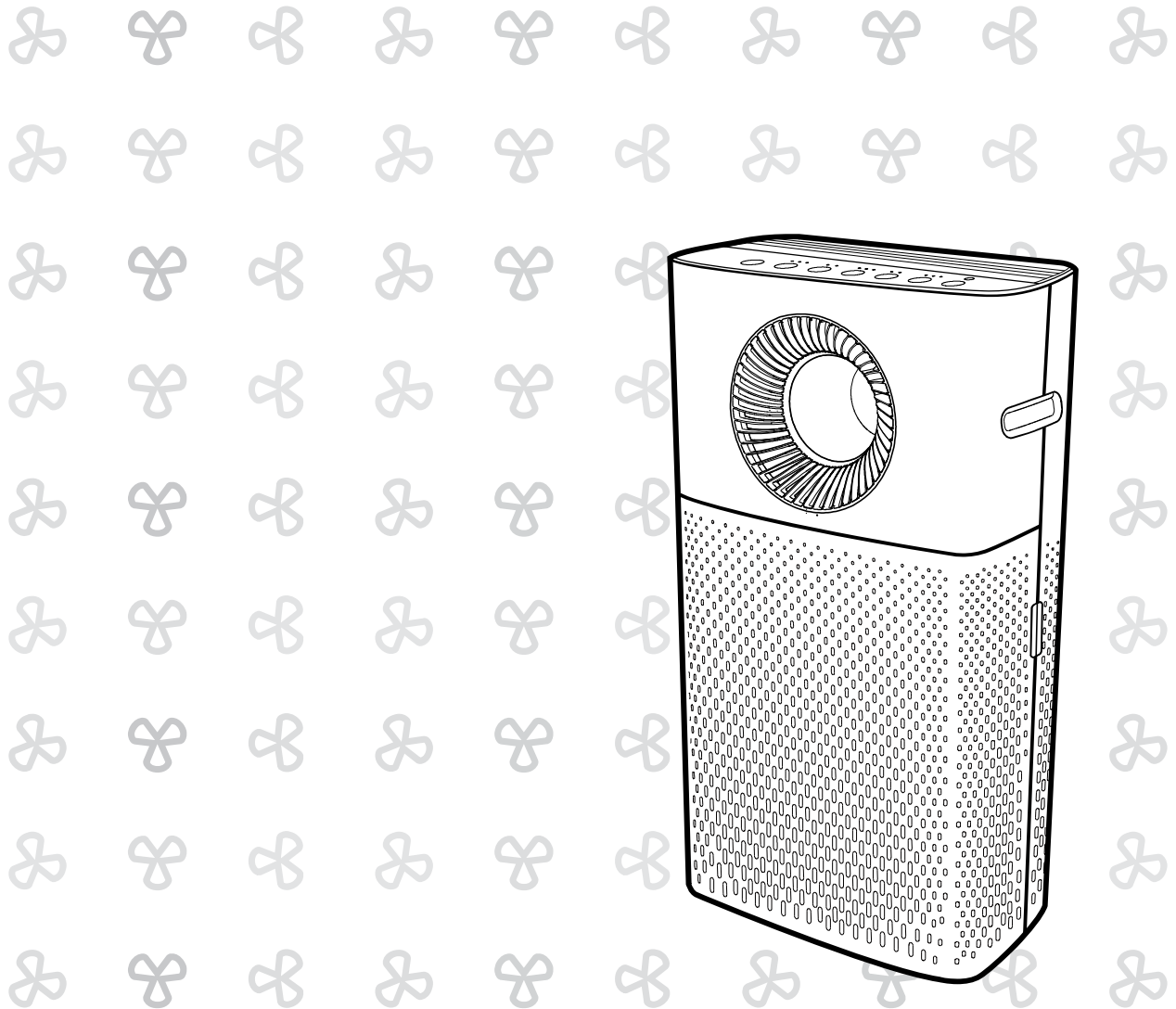

# FEATURES

---

## 1. Excellent air cleaning

The cleaning filter system has been optimized for reduction of bacteria and removal of invisible ultrafine dust and others from indoor air.

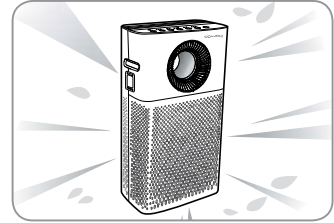

## 2. Powerful clean air flow

Quickly circulates purified air in different directions through normal flow, focused flow, and multi-flow.

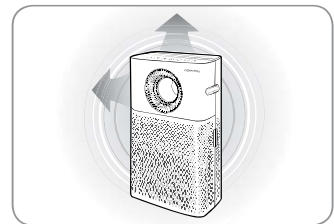

## 3. Fine Dust Filter

The fine dust filter effectively captures not only large dusts but also fine dusts such as pollen, mold, and pet dander.

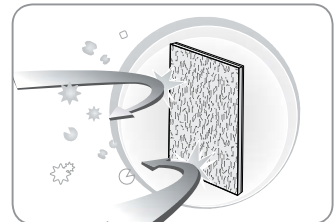

## 4. Real-time air purification display

Four colored indicators provide visible notice of current air quality in real time .

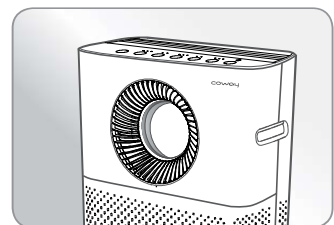

## 5. Detachable outlet grilles

Detachable outlet grilles are installed on top/front of the product for easier, more effective cleaning than in other products with fixed covers.

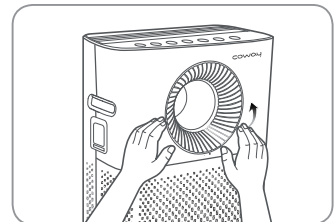

# DEAR CUSTOMERS

---

Thank you for using the **Coway air purifier**.  
Please be sure to read this user manual to use and maintain your air purifier correctly.  
If you experience any problems during use, you can refer to this user manual to resolve them.  
This user manual contains the product warranty, so please store it safely.

## CONTENTS

### FOR INFORMATION

- | 03 | **SAFETY INFORMATION**
  - Danger
  - Warning
  - Caution
- | 07 | **PARTS NAME**
- | 09 | **AIR PURIFICATION PROCESS**

### MAINTENANCE

- | 17 | **CLEANING METHOD**
  - Product
  - Filter
- | 20 | **FILTER REPLACEMENT**

### HOW TO USE

- | 10 | **BEFORE USE**
  - How to install filter
- | 11 | **INDICATORS AND BUTTONS**
- | 13 | **HOW TO USE**
- | 16 | **ADJUST PARTICLE SENSOR**

### OTHERS

- | 22 | **TROUBLE SHOOTING**
- | 23 | **SPECIFICATION**

- Keep your user manual in a readily accessible or visible place. -

# SAFETY INFORMATION

---

## **This is safety information. Be sure to follow it!**

The warnings are to keep users safe and avoid damage to the product.

Please read them carefully and use the product correctly.

## **▲ DANGER : Failing to follow the precautions below may result in serious injury or even death.**

- Do not use damaged power plugs or loose sockets.
- The power plug must be plugged into only 220V-240V~50Hz/60Hz sockets.
- Do not pull on the power cord to move the product.
- Do not touch the power plug with wet hands.
- To avoid damaging or warping the power cord, do not use excessive force to bend the power cord or put heavy objects on top of it.
- Do not repeatedly connect and disconnect the power plug.
- If water enters the power supply, unplug the power and completely dry before using again.
- Be sure to unplug the power during product repair, maintenance or part replacement.
- If the power plug's pins or contact area become covered in dust or water, wipe them thoroughly.
- Do not plug several electric appliances into one socket, and use only a dedicated socket.
- Unplug the power when not being used for a long time.
- Do not carelessly connect or tamper with the power cord.
- If the supply cord is damaged, it must be replaced by the manufacturer, its service agent or similarly qualified persons in order to avoid a hazard.
- Do not install near electric heaters.
- Do not put on top of electric products like heaters or televisions.

- 
- Do not install in places with a lot of humidity or dust or places where water (rainwater) splashes.
  - Do not use or store combustible gases or flammable materials near this product.
  - If there is any strange sound, burning smell or smoke from the purifier, immediately unplug the power plug and contact a service center.
  - Never immerse the product in water.
  - Do not spray flammable materials such as insecticides or air fresheners on the intake.
  - Do not open, repair or modify the purifier yourself.
  - Do not put bowls of water, chemicals, food, small metal objects, or flammable materials on top of the purifier.
  - Clean after unplugging the power.
  - Do not spray water directly on the purifier or use benzene, thinners, etc. to wipe it during cleaning.
  - Do not insert sharp objects such as picks into the particle sensor.
  - Do not put fingers or foreign matter (pins, sticks, coins, etc.) into the outlet.
  - Do not let children hang from or climb on the purifier.
  - Be careful that children do not put their hands in the outlet.
  - Be careful that children do not put their hands into the hole of the product.
  - Replace the filter with a new one when the time comes.
  - Do not spray water directly on the purifier.

## SAFETY INFORMATION

---

**⚠ WARNING : Failing to follow the precautions below may result in considerable physical injury or property damage.**

- Do not unplug by pulling on the power cord.
- Do not use in baths, showers, swimming pools, or other areas where the purifier may be in direct contact with water.
- Children shall not play with the appliance.
- Cleaning and user maintenance shall not be made by children without supervision.

**⚠ CAUTION : Failing to follow the precautions below may result in slight physical injury or property damage.**

- Do not unplug the power or move the purifier while it is operating.
- If unusual sound, odor, or smoke comes from the purifier, immediately unplug the power and call our service center.
- Do not install on a slope.
- Do not excessively impact or use excessive force on this product.
- Use at least 20 cm away from walls or other objects on each side.
- Install the purifier in a place where it is not blocked on any side so air can circulate well.
- Do not use in BBQ or other restaurants where odor, smoke, or oil may occur.
- Do not use in direct sunlight.
- Do not install in a high place.
- Do not touch the controls while power is turning on.

- 
- Do not push or lean on the purifier. The purifier may fall over.
  - Do not use the product for any purpose other than air purification.
  - Do not let a person be exposed to breeze expelled from the front of purifier for a long time.
  - Do not allow breeze expelled from the purifier front near your face.
  - Do not use for a long time in places that are sealed or where children, the elderly or sick are.
  - Do not block the outlet with laundry or curtains.
  - Remove dust from the pre-filter with a vacuum cleaner or water.
  - Periodically wash the pre-filter and dry it sufficiently in a shady place with good ventilation.
  - Do not repeatedly push the flow mode or quick cleaning mode buttons.
  - This appliance can be used by children aged from 8 years and above and persons with reduced physical, sensory or mental capabilities or lack of experience and knowledge if they have been given supervision or instruction concerning use of the appliance in a safe way and understand the hazards involved.
  - Children should be supervised to ensure that they do not play with the appliance.

**READ AND SAVE THESE INSTRUCTIONS**

# PARTS NAME

## Rear / Front

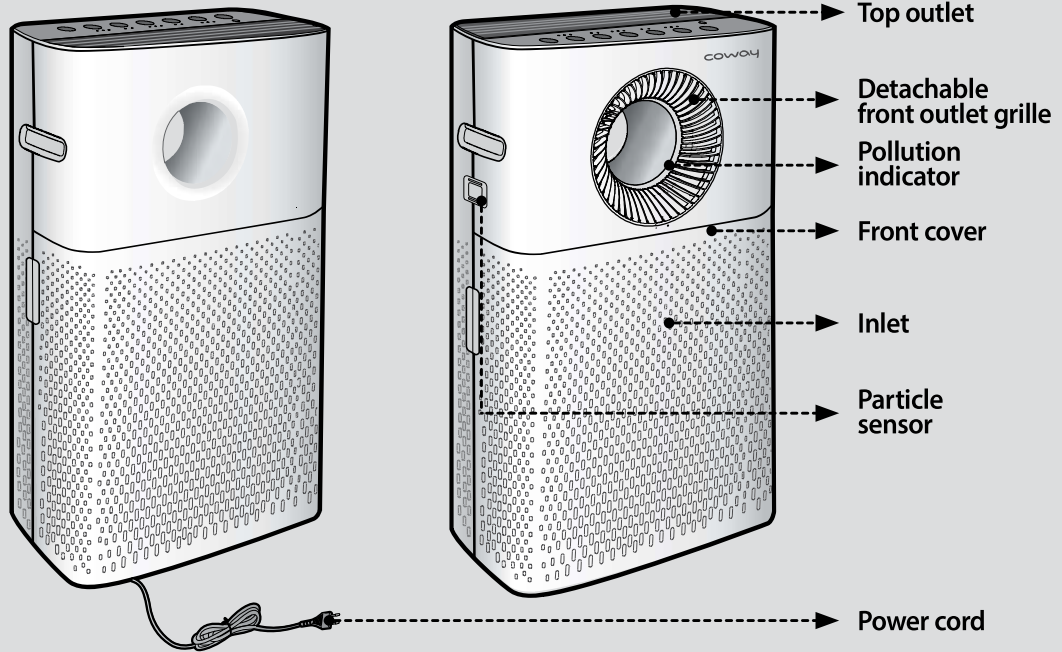

## Top

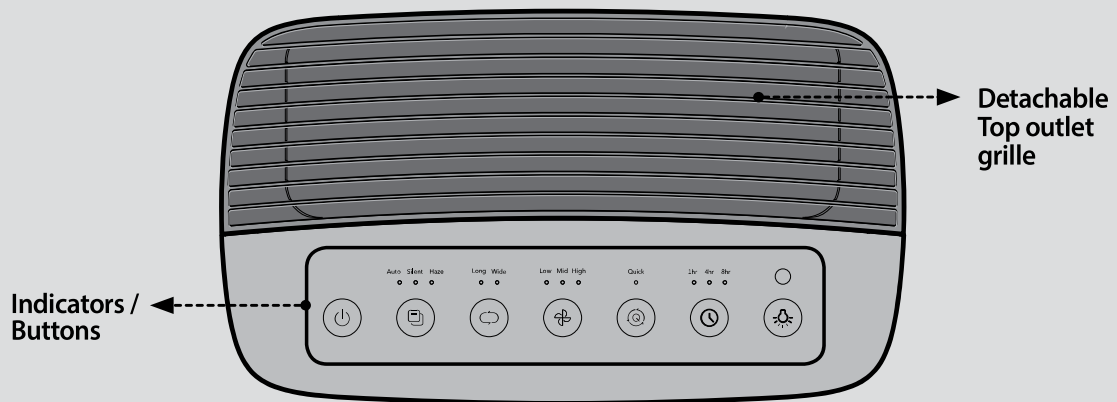





## Components



User manual

# AIR PURIFICATION PROCESS

---

## ■ Pre-filter

Removes relatively large dust and mold, hair, pet fur, etc.

The superfine fiber net decreases pressure damage to the filter and increases dust collection efficiency.

## ■ Fine Dust filter

The fine dust filter effectively captures not only large dusts but also fine dusts such as pollen, mold, and pet dander.

\*When you assemble the fine dust filter, be sure that the blue side of the filter must be at the front.

## ■ Deodorization filter

The granular activated carbon deodorization filter effectively removes odors including food smells and musty house smells and harmful gases indoors.

## ■ HEPA filter

The high-performance synthetic HEPA filter is excellent at removing cigarette smoke and fine dust.

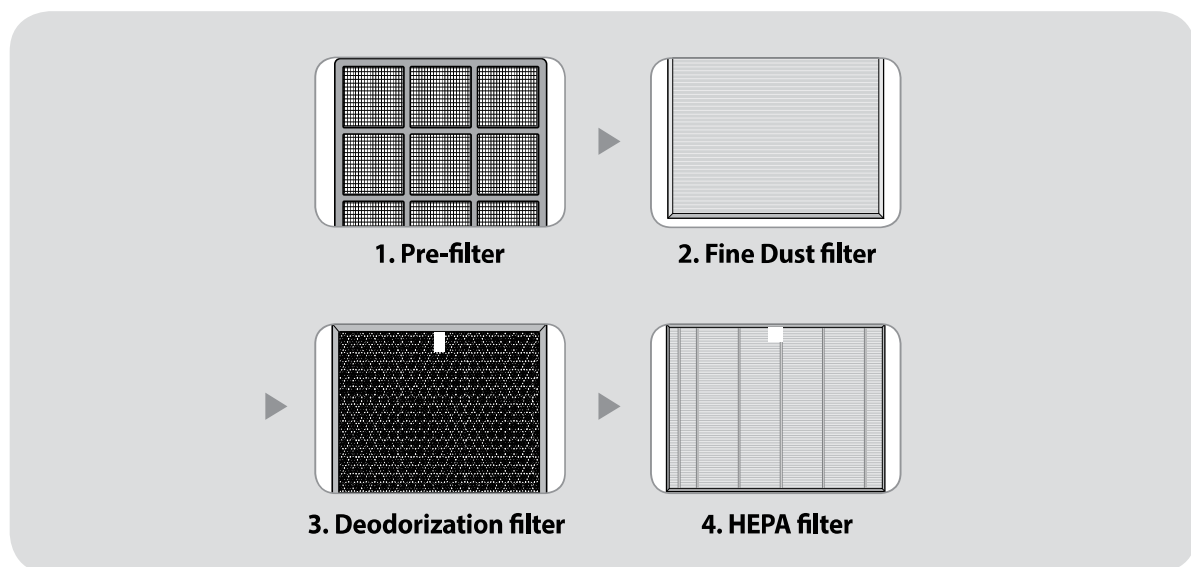

# BEFORE USE

## Please check before use

- ⚠ The product is for 220V-240V~50Hz/60Hz.  
Make sure to connect the power plug to a grounded electric outlet (220V-240V~50Hz/60Hz) dedicated to the product.

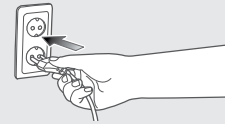

### How to install filter



Tips

- Be sure to install the filter after removing the plastic packaging.
- Only use it indoors.
- When not in use, remove the power plug from the socket.
- During filter assembly, check the front of the filters.
- ▶ Filter assembly order : HEPA filter → deodorization filter → fine dust filter → pre-filter

### 1. Open the front cover.

Pull both sides of the front cover to open.

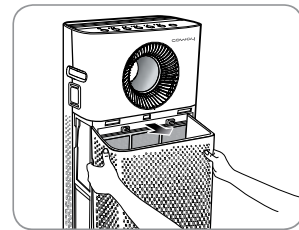

### 2. Take out the filter and remove the plastic packaging.

Remove the plastic packaging from filters, excluding the Pre-filter, and assemble them in the purifier in order.

Install the fine dust filter behind the Pre-filter.

- \* Filter assembly order : HEPA filter → deodorization filter → fine dust filter → pre-filter
- \* When you assemble the fine dust filter, be sure that the blue side of the filter must be at the front.

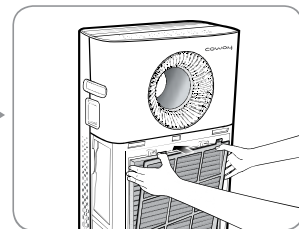
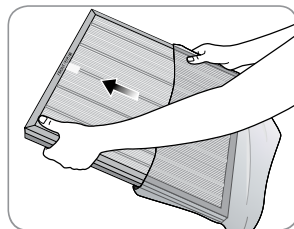

### 3. Reattach the front cover.

Push to reattach the front cover into the two slots on the sides of the purifier.

- \* If the front cover is not properly attached, the product will not operate.

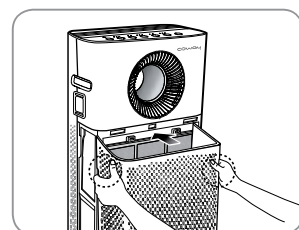

# INDICATORS AND BUTTONS

## Indicators

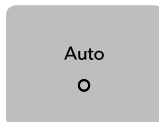
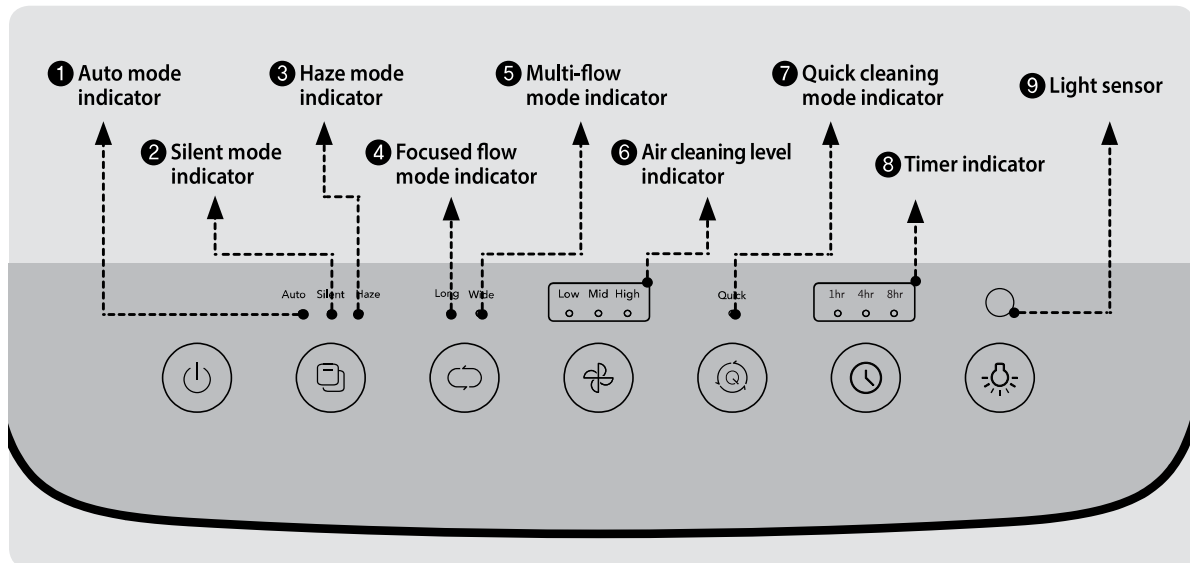

**1 Auto mode indicator**  
This indicator is illuminated if auto mode is on.



**2 Silent mode indicator**  
This indicator is illuminated if silent mode is on.



**3 Haze mode indicator**  
This indicator is illuminated if Haze mode is on.

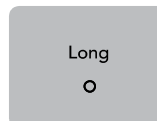

**4 Focused flow mode indicator**  
This indicator is illuminated if focused flow mode is on.



**5 Multi-flow mode indicator**  
This indicator is illuminated if multi-flow mode is on.

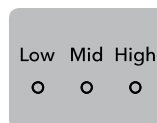

**6 Air cleaning level indicator**  
This indicator is illuminated if Low/Mid/High Air cleaning level is on.



**7 Quick cleaning mode indicator**  
This indicator is illuminated if Quick cleaning mode is on.

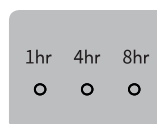

**8 Timer indicator**  
1 hr, 4 hr, and 8 hr indicators are illuminated if Timer is on.

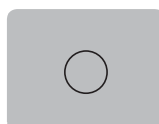

**9 Light sensor**  
This sensor detects light around the purifier.

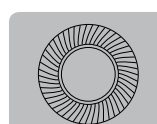

**10 Pollution indicator**  
Indoor pollution is shown by LED color. Clean (blue) → Slight (green) → Heavy (yellow) → Severe (red)

Buttons

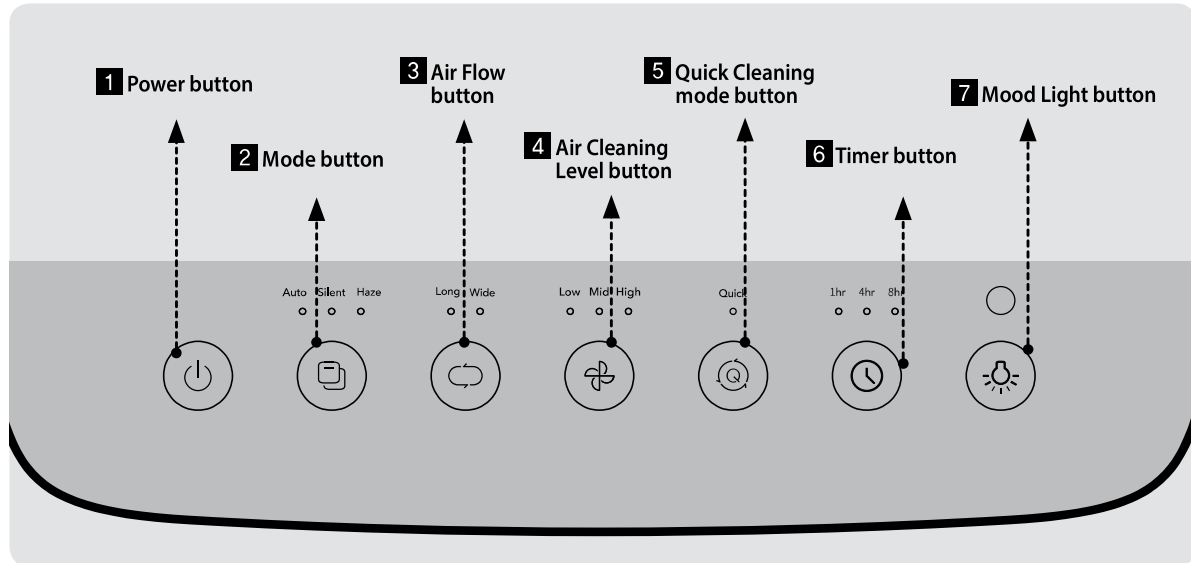

**1 Power button**

Use when turning the purifier on and off.

\* When you first start the purifier, it runs in auto mode, and if you turn it off and then on again while it is operating, it restarts in the mode operating before it was turned off (however, it reverts to auto mode if that mode was a Air Flow or quick cleaning mode)



**2 Mode button**

Press the mode button to go from Auto → Silent → Haze mode.

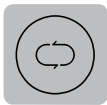

**3 Air Flow button**

Press the Air Flow button to cycle between focused flow → multi-flow → mode before focused flow.

\* However, the purifier reverts to auto mode if the previous mode was quick cleaning mode.  
 -Focused flow : breeze comes from the front of the purifier.  
 -Multi-flow: Breeze comes from the front and top of the purifier simultaneously.



**4 Air Cleaning Level button**

Press the Air Cleaning Level button to cycle between Low → Mid → High air volume.

If you press the Air Cleaning Level button during mode operation (Auto/Silent/Haze) or quick cleaning mode operation, the purifier immediately switches to manual mode.



**5 Quick Cleaning mode button**

Press the Quick Cleaning mode button to turn on quick cleaning mode.

\* Quick cleaning mode is a unified function. You cannot use it during mode operation (Auto/Silent/Haze), flow mode, or manual operation.



**6 Timer button**

Press the timer button to reserve a shutoff time by cycling between 1 hr → 4 hr → 8 hr → cancel reservation. All indicators turn off when shutoff reservation is canceled.



**7 Mood Light button**

Use when turning the indicators and pollution indicator on or off. Press the Mood Light button while all indicators and the pollution indicator are on to turn indicators off by cycling between pollution indicator off → all indicators off → all indicators on.

# HOW TO USE



Tips

- Plug the power plug into a socket before operating the purifier.
- When the purifier is turned on, it starts in auto mode by default.

## Normal flow

In normal flow mode, breeze is expelled from the purifier's top outlet. Press the power button to turn the purifier on and choose the mode you want from manual operation or mode operation (Auto/Silent/Haze). Manual and mode operation (Auto/Silent/Haze) operate as normal flow modes.

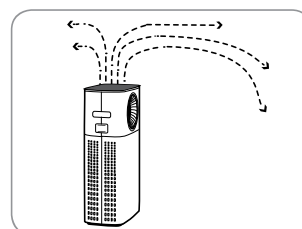

### ■ To operate manually

Press the power button to turn on the purifier and press the air cleaning level button to select your desired air cleaning level. (Low → Mid → High)

\* Press the air cleaning level button during mode operation (Auto/Silent/Haze) to immediately convert to manual operation.

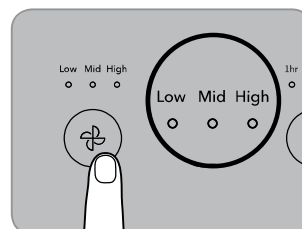

### ■ To use mode operation

Press the power button to turn on the purifier and press the mode button to select your desired operating mode. (Auto → Silent → Haze)

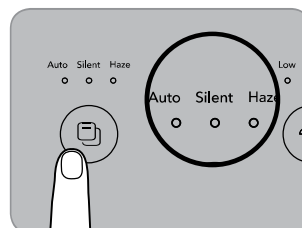

#### ▶ Auto mode

Operates effectively by automatically adjusting the purifier's air volume (Low → Mid → High) depending on the indoor pollution level detected by the sensor. This is a convenient operating mode for most users.

	Pollution level 1	Pollution level 2, 3	Pollution level 4
Air cleaning level	Low	Mid	High

#### ▶ Silent mode

Minimizes air cleaning level during operation to create a quiet, comfortable environment. This operating mode is quiet and consumes less power.

\* The air cleaning level indicator is off in silent mode.

#### ▶ Haze mode

Maximizes air cleaning level during operation to quickly create a comfortable environment. Haze mode uses a higher air cleaning level than "high air cleaning level".

#### ▶ Sleep mode (only works in auto mode)

If the area around the purifier darkens for at least 3 minutes while it is operating in auto mode, the purifier automatically converts to low air cleaning level, low noise, low power consumption mode.

Sleep mode will be cancelled if the area around the purifier lightens for 5 minutes. The indicator for Sleep mode (on/off) varies depending on the previous status of the indicator. Please refer to the below table.

\* In Auto/Silent/Haze/Sleep modes, breeze is expelled from the Top outlet in normal flow mode.

Indicator status	Operation part/Pollution indicator before entering Sleep mode	Auto mode indicator/Pollution indicator when Sleep mode is on	Operation part/Pollution indicator when Sleep mode is off
	ON / ON	ON / OFF	ON / ON
	ON / OFF	ON / OFF	ON / OFF
	OFF / OFF	OFF / OFF	OFF / OFF

### Focused flow

In focused flow mode, breeze is expelled from the purifier's front Outlet. Press the power button to turn on the purifier and press the flow mode button to select focused flow mode.  
(Focused flow → multi-flow → mode before focused flow)  
When focused flow is on, it initially operates with low air cleaning level.

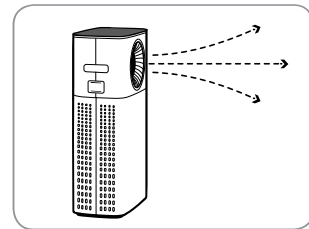

#### ■ To select air cleaning level

Select focused flow mode and press the air cleaning level button to select your desired air cleaning level. (Low → Mid → High)

- \* Press the mode button or quick cleaning mode button while in focused flow mode to turn off the flow mode.
- \* When using focused flow mode, the pollution indicator LED turns clockwise while turning on.

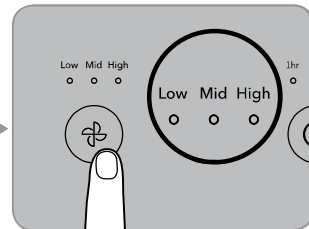
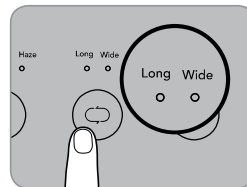

### Multi-flow

In multi-flow mode, breeze is expelled from the purifier's front and top outlet. Press the power button to turn on the purifier and press the flow mode button to select multi-flow mode.  
(Focused flow → multi-flow → mode before focused flow)  
When multi-flow is on, it initially operates with low air cleaning level.

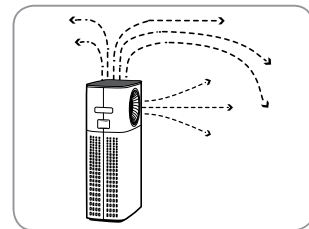

#### ■ To select air cleaning level

Select multi-flow mode and press the air cleaning level button to select your desired air cleaning level. (Low → Mid → High)

- \* Press the mode button or quick cleaning mode button while in multi-flow mode to turn off the flow mode.
- \* When using multi-flow mode, the pollution indicator LED turns clockwise while repeating on ↔ off.

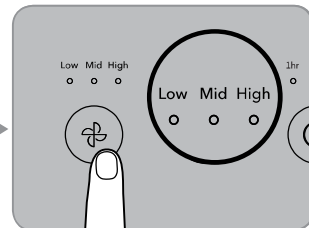
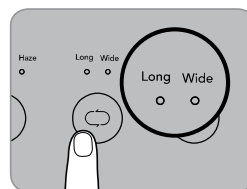

# HOW TO USE



Tips

- Do not repeatedly press the Air Flow button. The breeze direction may differ from its initial setting.
- \* Choose normal flow to change the breeze direction, then choose the mode you want to use.

## Quick cleaning

This operating mode can effectively remove dust in your house the most quickly. It operates in 3 stages for a set time at maximum air cleaning level(Haze).

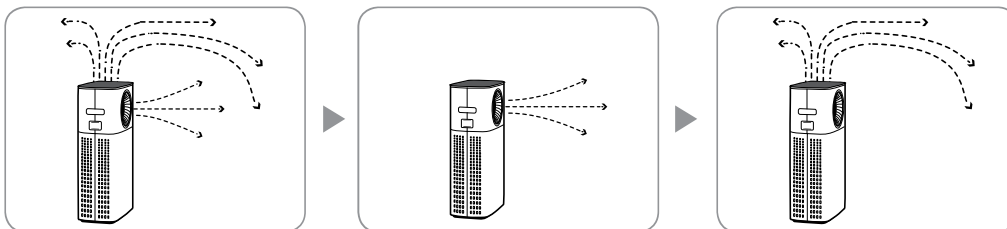
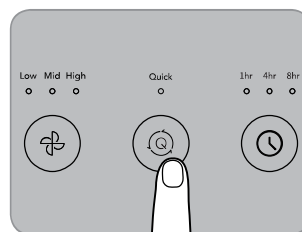

Level	Mode and operating time
1	Multi-flow (3 minutes)
2	Focused flow (2 minutes)
3	Normal flow (5 minutes)

- \* Quick cleaning only operates with Haze air cleaning level.
- \* Quick cleaning operates the pollution indicator and air direction to match the mode at each stage. Only the quick cleaning indicator is on regardless of mode at each stage.
- \* When all three stages of quick cleaning are complete, the purifier reverts to auto mode.
- \* Press the mode/air flow/air cleaning level/quick cleaning mode buttons while in quick cleaning mode to turn this mode off.
- \* When you press the quick cleaning mode button to turn it off, the purifier returns to the previous mode. However, if the previous mode was a Air Flow(focused/multi), it runs in auto mode.



Tips

- Do not repeatedly press the quick cleaning mode button. The breeze direction may differ from its initial setting.
- \* Choose normal flow to change the breeze direction, then choose the mode you want to use.



# ADJUST PARTICLE SENSOR

## How to adjust the sensitivity of the particle sensor

When you first turn on the purifier, the particle sensor is set to standard. You can adjust the sensitivity as follows if the pollution indicator stays at severe even after the purifier runs for 2 hours or more with high pollution or the pollution indicator stays at clean even if the pollution is high.

**1. Press the air cleaning level and mode buttons simultaneously for at least 1 second while the purifier is operating.**

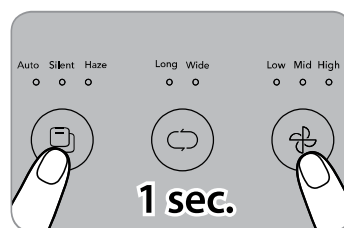

**2. The air cleaning level indicator flashes at intervals of about 0.5 second.**

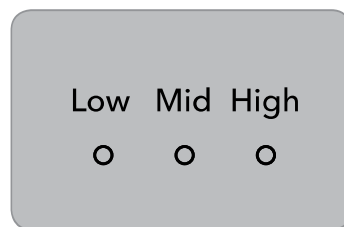

**3. Press the air cleaning level button to adjust to your desired sensor sensitivity. When sensor sensitivity is selected, the air cleaning level indicators flash as follows.**

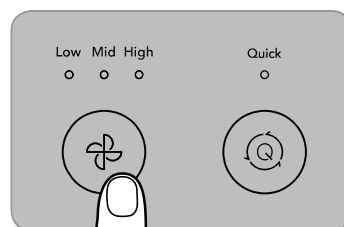

Air cleaning level low	Air cleaning level mid	Air cleaning level high
Sensitive	Standard	Insensitive

**4. Press the air cleaning level and mode buttons simultaneously for at least 1 second again to enter your selected sensitivity to operate the purifier normally.**

\* If the air cleaning level button and mode button are not pressed for 10 seconds after selecting sensitivity, the selected sensitivity is automatically input.

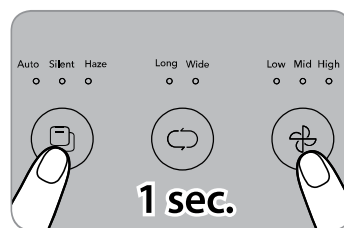

# CLEANING METHOD



Tips

- Always unplug the power cord before cleaning.
- Do not use detergents containing organic solvents (solvents, thinners, etc.), bleach, chlorine or abrasives to clean.
- Do not immerse the purifier in water or sprinkle water on it.

## ■ Cleaning the outlet and detachable outlet grille

Lift the detachable outlet grille on top of the outlet, then clean the grille and outlet with a soft brush or vacuum cleaner.

- \* Be careful not to let dust enter the outlet while cleaning.
- \* When reassembling the upper detachable outlet grille, put the grille tabs into the purifier slots as in the picture on the right.

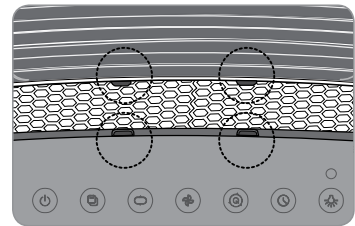
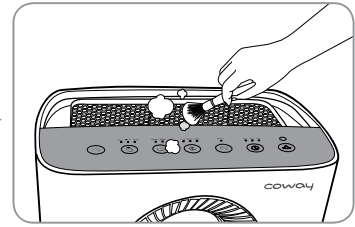
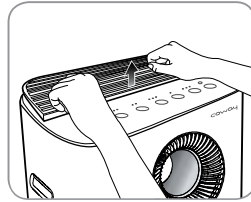

## ■ Cleaning the detachable front grille

Turn the front grille counterclockwise while removing it. Clean the detached front grille outlet with a soft brush or vacuum cleaner.

When cleaning inside the purifier, wipe with a soft, dry cloth.

- \* If there is severe pollution, wipe with a damp cloth (do not use abrasives).
- \* Take care that dust does not fall inside the purifier while cleaning.

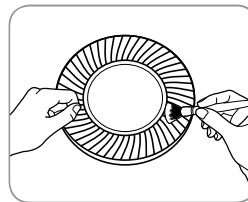
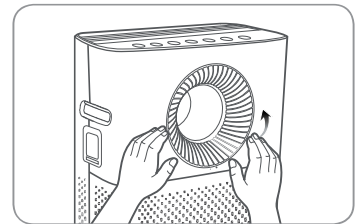

[Cleaning the grille]

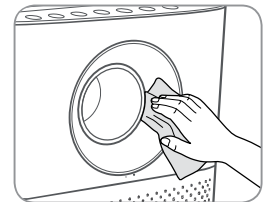

[Cleaning the interior]

- ⚠ When reassembling after cleaning the front grille, line up the front grille with the display. Turn the front grille clockwise to fix it in place.

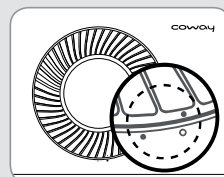

[While grille is opened]

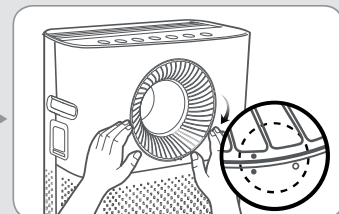

[While grille is closed]

**■ Cleaning the particle sensor (clean every 2 months)**

1. Clean the particle sensor air inlet and outlet with a soft brush or vacuum cleaner.
  - \* Take care that dust does not fall inside the purifier while cleaning.

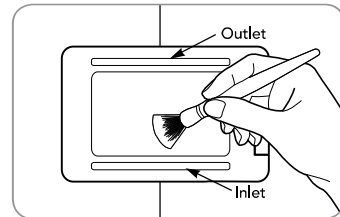

2. Open the particle sensor cover on the upper side of the purifier. (Use the particle sensor cover slots to open the cover.) Wet a cotton ball with a small amount of water and wipe the lens, dust inlet and outlet, then wipe again with a dry cotton ball to remove moisture.

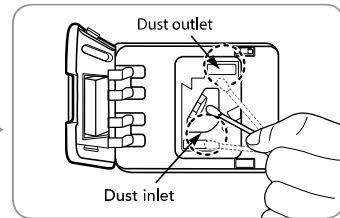
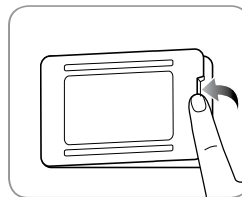

- \* If cleaning is not done regularly, the performance of the particle sensor may decrease.
- \* Clean more often in very dusty environments.

**■ Cleaning the front cover**

- Remove the front cover from the purifier and then wipe away dust stuck to the surface with a soft, dry cloth or soft brush.
- \* If there is severe contamination, use a damp cloth (do not use abrasives).

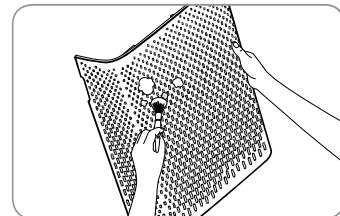

**■ Cleaning the purifier**

- Wipe with a soft, dry cloth.
- \* If there is severe contamination, use a damp cloth (do not use abrasives).

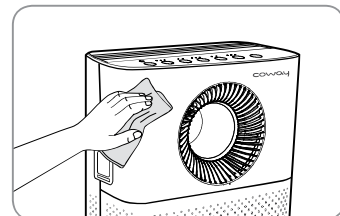

# CLEANING METHOD

---



Tips

- Always unplug the power cord before cleaning the filter.
- The pre-filter can be reused after dust removal and cleaning with water.
- If the pre-filter is not cleaned for a long time, the product performance may decrease and problems may occur.
- The fine dust filter, deodorization filter and HEPA filter cannot be reused after cleaning. Never clean them with water.

## ■ Pre-filter (clean every 2-4 weeks)

1. Pull both sides of the front cover to open.

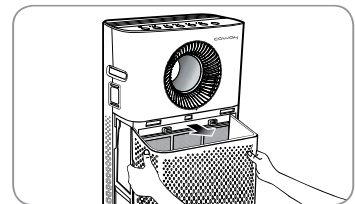

2. Pull the pre-filter handle while taking it out to separate it from the fine dust filter.

- \* Be careful that dust doesn't fall out during removal.

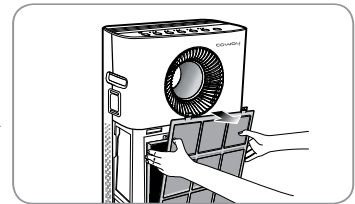
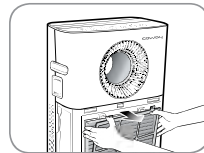

3. Remove dust with water or a vacuum cleaner depending on the degree of contamination.

- \* Be careful not to let dust enter the purifier while cleaning.

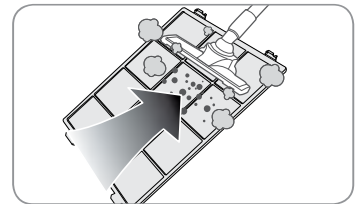

4. Push the completely dry pre-filter all the way into the purifier to install it. Close the front cover again.

- \* When you assemble the fine dust filter, be sure that the blue side of the filter must be at the front

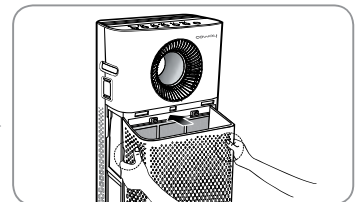
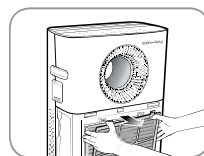

# FILTER REPLACEMENT

## ■ How to replace

- Refer to the filter installation method specified on page 10 to replace the filters.
- During filter assembly, be sure to check the front.
- Only use genuine Coway filters to keep the purifier at its optimal performance.
- Always unplug the power plug before replacing filters.

## ■ Filter cleaning and replacement cycle

Filter	Cleaning / replacement time	Cleaning / replacement
Pre-filter	Once / 2-4 weeks	Clean and wash
Fine Dust filter	Once / 4 months	Replace
Deodorization filter	Once / 24 months	Replace
HEPA filter	Once / 12 months	Replace

\* Based on 24 hour (1 day) use at low air cleaning level

\* The filter replacement cycle is the recommended cycle and may vary depending on usage environment.

# FILTER REPLACEMENT

---

## ■ How to replace Fine Dust filter (replace every 4 months)

1. Open the front cover and remove the pre-filter from the purifier, then detach the fine dust filter from the pre-filter.

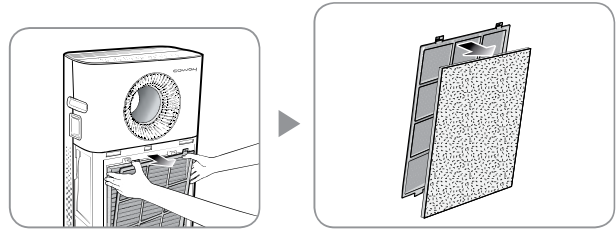

2. Remove the plastic packaging from the new fine dust filter, then put it on the back of the superfine fiber net pre-filter. Reassemble the pre-filter into the purifier in the reverse order you removed it, then close the front cover.

\* When you assemble the fine dust filter, be sure that the blue side of the filter must be at the front.

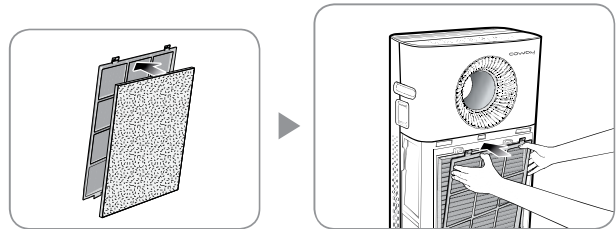

## ■ How to replace Deodorization/HEPA filters (replace every 24/12 months)

1. Open the front cover and remove the pre-filter and fine dust filter from the purifier, then take out the deodorization filter and HEPA filter.

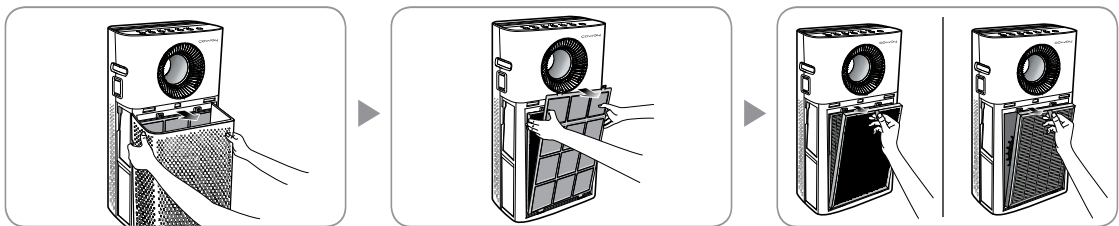

2. Replace them with a new deodorization filter and new HEPA filter with the plastic packaging removed. Reassemble the purifier in the reverse order you disassembled it and close the front cover.

\* Check the filters' front display.

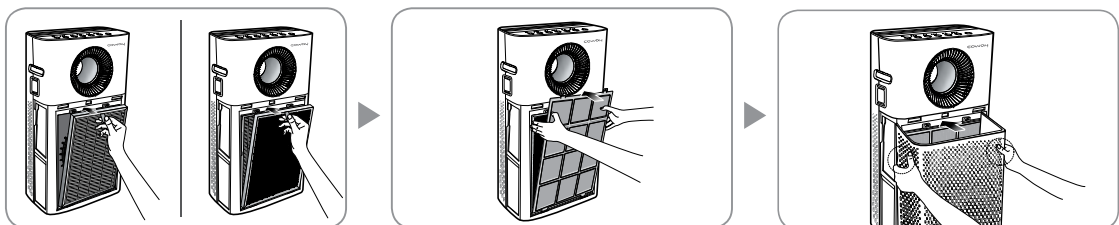

# TROUBLE SHOOTING

The product may not operate correctly due to trivial reasons or inexperienced usage, although these are not product malfunctions. In such cases, the problem can be solved easily without the help of a service center if the following items are checked. If the problem is not resolved even after checking the following, please contact a service center.

Problem	Check	Steps to take
There is no breeze.	• Is the power plugged in?	The power plug must be plugged into 220V–240V~50Hz/60Hz socket.
	• Is the entire display off?	Press the power button, then select your desired function.
	• Is there a power failure?	After the power comes back on, use the purifier.
Air cleaning level doesn't change.	• Is the purifier operating in manual mode?	Turn on your desired operating mode.
	• Is the purifier operating in Haze/Silent mode?	Air cleaning level is not selected in haze/silent modes, but rather runs at a set level.
	• Is the room dark?	Air cleaning level is set at minimum during sleep mode.
	• Is the purifier operating in Quick cleaning mode?	Air cleaning level is set at maximum during quick cleaning mode.
Air cleaning level is very low.	• Is it past time for filter cleaning and replacement?	Check your filter cleaning and replacement cycle and clean or replace filters.
Pollution level doesn't change.	• Is there dust on the particle sensor lens ?	Clean the particle sensor lens (p. 18).
	• Does the pollution level continuously appear high?	Set sensor sensitivity to insensitive or standard (p. 16).
	• Does the pollution level continuously appear low?	Set sensor sensitivity to sensitive or standard (p. 16).
There's a smell from the outlet.	• Is it past time for filter cleaning and replacement?	Check your filter cleaning and replacement cycle and clean or replace filters.
The pollution indicator flickers.	• Request service.	
If other functional flaws occur	• Check the problem, then unplug the power and request service.	

# SPECIFICATION

Product name	Air purifier
Model name	AP-1516D
Dust collection method	Mechanical dust collection method(HEPA filter)
Safety equipment	Power is shut down when the front cover is opened
Installation location	For indoor use
Coverage	532.8 ft <sup>2</sup> (49.5 m <sup>2</sup> )
Maximum air cleaning level	8.2 m <sup>3</sup> /min
Product size	410 mm (width) x 240 mm (depth) x 765 mm (height)
Product weight	12 kg

- ▶ Specifications may vary slightly without prior notice to improve product performance.
- ▶ Data was measured for Coverage and maximum air cleaning level in normal flow mode and Haze mode.

**COWAY**

Add : Coway co., Ltd.  
136-23, Yugumagoksa-ro, Yugu-eup, Gongju-si,  
Chungcheongnam-do, Korea  
Tel. : 82-1588-5100

**USA**

Add : Coway USA Inc.  
4221 Wilshire Blvd. #210 Los Angeles, CA90010  
Call center. : (213) 386-3033  
Fax. : (213) 386-3032

**THAILAND**

Add : COWAY(THAILAND) CO., LTD.  
75/104-106 Ocean Tower2 38Fl, Soi  
Sukhumvit19(Wattana), Sukhumvit Road,  
Klongtoey Nua, Wattana, Bangkok 10110  
HQ : 66-2-261-2610  
Call center : 66-2-261-0209

**MALAYSIA**

Add: COWAY (M) SDN BHD  
SUITE 6-3 & 6-4 LEVEL 6, WISMA UOAI  
NO.21 JALAN PINANG 50450 KUALA LUMPUR  
Call center : 1-800-888-111



# MEMO



# MEMO



# MEMO



coway

[www.coway.com](http://www.coway.com)