



The LT controllers provide manual control of the rotational speed of voltage controllable (230 VAC / 50 Hz) motors by varying the supplied voltage through phase angle control. They are suitable for both inset and surface mounting. The splash-proof housing allows use in tough working environments. An orange LED indicates the operation status. Several motors can be connected as long as the current limit is not exceeded. All models have an extra (unregulated) 230 VAC output. These speed controllers offer an excellent and accurate regulation.

#### Key features

- Infinitely variable speed control
- Regulation from minimum to maximum speed (LTY) and from maximum to minimum speed (LTX)
- Minimum speed adjustable by internal trimmer
- Fuse 5\*20 mm, spare fuse included
- Operating LED indication

#### Area of use

- Manual control of the motor / fan speed in HVAC applications
- For indoor use only

#### Article codes

Article code	Rated current range [A]	Fuse (5*20 mm) [A]
<b>LOW TO HIGH SPEED</b>		
LTY-0-05-AT	0,05—0,5	F-0,63 A-H
LTY-0-15-AT	0,1—1,5	F-2,00 A-H
LTY-0-25-AT	0,2—2,5	F-3,15 A-H
LTY-0-40-AT	0,4—4,0	F-5,00 A-H
<b>HIGH TO LOW SPEED</b>		
LTX-0-05-AT	0,05—0,5	F-0,63 A-H
LTX-0-15-AT	0,1—1,5	F-2,00 A-H
LTX-0-25-AT	0,2—2,5	F-3,15 A-H
LTX-0-40-AT	0,4—4,0	F-5,00 A-H

#### Technical specifications

Power supply	230 VAC ±10 % / 50 Hz	
Regulated output	80—230 VAC	
Unregulated output	230 VAC / max. 2 A	
Minimum speed adjustment	80—180 VAC	
Ambient conditions	Temperature	0—35 °C
	Relative humidity	< 100 % rH (non-condensing)
Protection standard	IP44 / IP54 (according to EN 60529)	

#### Wiring and connections

↑	Power supply (230 VAC ±10 % / 50 Hz)
↓	Unregulated output voltage 230 VAC / max. 2 A
N	Neutral
	Regulated output to motor
Connections	Cable cross section: max. 2,5 mm <sup>2</sup>

**Note:** To disable the OFF position, connect the 230 VAC supply voltage to the unregulated output (↓). In this case, do not connect the power supply to ↑.



#### Settings

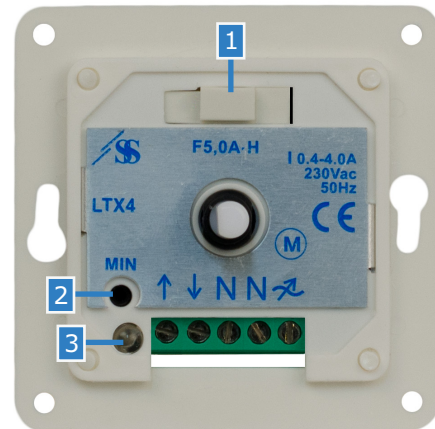

1 - Fuse holder		with a spare fuse
2 - Minimum speed adjustment trimmer		Adjusts the min. speed (factory preset 100 VAC)
3 - Operating LED indication	Continuous orange	Normal operation

#### Standards

- Low Voltage Directive 2014/35/EC
  - EN 60335-1:2012 Household and similar electrical appliances - Safety - Part 1: General requirements. Amendment A11:2014 and AC:2014 to EN 603351:2012
  - EN 61558-1:2005 Safety of power transformers, power supplies, reactors and similar products - Part 1: General requirements and tests. Amendment A:2006 and A1:2009 to EN 61558-1:2005
- EMC Directive 2014/30/EC:
  - EN 61000-6-2: 2005 Electromagnetic compatibility (EMC) - Part 6-2: Generic standards - Immunity for industrial environments. Amendment AC:2005 to EN 61000-6-2:2005
  - EN 61000-6-3:2007 Electromagnetic compatibility (EMC) - Part 6-3: Generic standards - Emission standards for residential, commercial and light-industrial environments. Amendment A1:2011 and AC:2012 to EN 61000-6-3:2007
- WEEE Directive 2012/19/EU
- RoHS Directive 2011/65/EU



#### Operational diagrams LTY (minimum to maximum)

OFF position enabled: supply voltage connected to ↑ and N

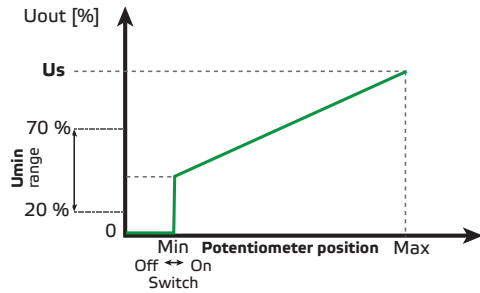

OFF position disabled: supply voltage connected to ↓ and N

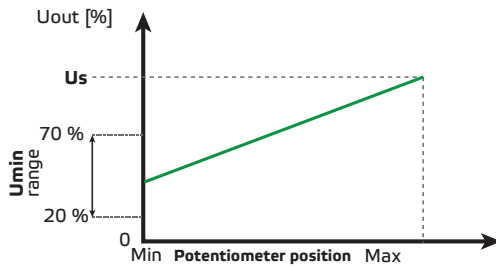

#### Operational diagrams LTX (maximum to minimum)

OFF position enabled: supply voltage connected to ↑ and N

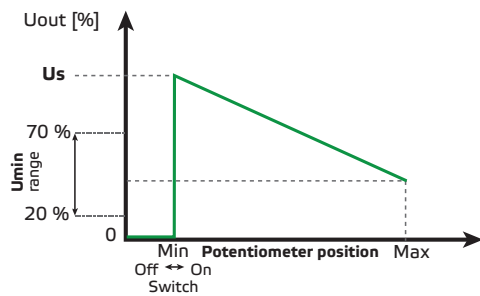

OFF position disabled: supply voltage connected to ↓ and N

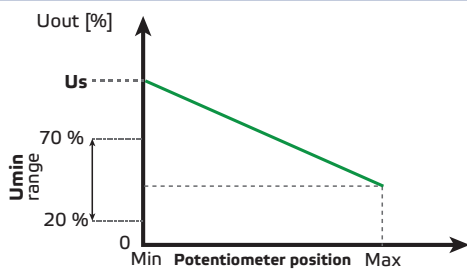

#### Fixing and dimensions

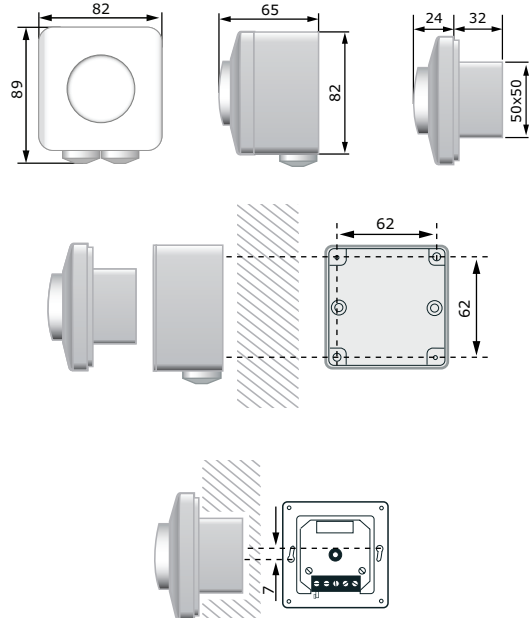

Attention! LTX-0-40-AT and LTY-0-40-AT are suited for surface mounting only!

#### Packaging

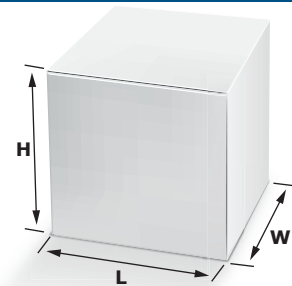

Article	Packaging	Length [mm]	Width [mm]	Height [mm]	Net weight	Gross weight
LTX-0-05-AT LTY-0-05-AT	Unit (1 pc.)	95	85	70	0,16 kg	0,19 kg
	Carton (10 pcs.)	492	172	84	1,55 kg	1,99 kg
	Box (60 pcs.)	590	380	280	9,3 kg	12,5 kg
LTX-0-15-AT LTY-0-15-AT LTX-0-25-AT LTY-0-25-AT	Unit (1 pc.)	95	85	70	0,173 kg	0,193 kg
	Carton (10 pcs.)	492	172	84	1,73 kg	2,08 kg
	Box (60 pcs.)	590	380	280	10,38 kg	13,47 kg
LTX-0-40-AT LTY-0-40-AT	Unit (1 pc.)	95	85	70	0,237 kg	0,257 kg
	Carton (10 pcs.)	492	172	84	2,37 kg	2,72 kg
	Box (60 pcs.)	590	380	280	14,22 kg	17,31 kg



**LT**

Electronic fan speed controller

**Global trade item numbers (GTIN)**

Packaging	Unit	Carton	Box
<b>LTX-0-05-AT</b>	05401003008577	05401003301265	05401003501924
<b>LTY-0-05-AT</b>	05401003008607	05401003301302	05401003501962
<b>LTX-0-15-AT</b>	05401003008584	05401003301272	05401003501931
<b>LTY-0-15-AT</b>	05401003008621	05401003301319	05401003501979
<b>LTX-0-25-AT</b>	05401003008591	05401003301289	05401003501948
<b>LTY-0-25-AT</b>	05401003008638	05401003301326	05401003501979
<b>LTX-0-40-AT</b>	05401003008607	05401003301296	05401003501955
<b>LTY-0-40-AT</b>	05401003008645	05401003301333	05401003501993